



- **HL-1000/1500/2000/3000/4000/6000/8000/12000/15000/20000/30000/40000/50000 Series**
- **SCH-/1500/2000/3000 Series**
- **SCL-/1500/2000/3000 Series**
- **SCHYTJ-/1500/2000/3000 Series**
- **SY-1500/2000 Series**

User's Manual of Fiber Laser Chiller

WUHAN HANLI REFRIGERATION TECHNOLOGY CO., LTD.

Add: No. 1, Second Road, XinFuYua, Hannan District, Wuhan, China

Post Code: 430090 Email: hanli-laserchiller@hanlizl.com

Tel: +86-13682641130 ,

www.hanlichiller.com

Content

foreword	-----	4
Warning notices	-----	5
1 Overview	-----	8
2 Conditions of use	-----	8
2.1 Environmental requirements	-----	8
2.2 Medium requirements	-----	9
3 Model description	-----	10
4 Model description	-----	10
5 Appearance and part name	-----	12
6 Installation	-----	12
6.1 Installation conditions and requirements	-----	12
6.2 Waterway connection	-----	14
6.3 Circuit connection	-----	14
6.4 Add water and exhaust	-----	15
6.4.1 Add water	-----	15
6.4.2 Exhaust and drainage	-----	15
6.5 Warm Tips	-----	16
7 Product use	-----	16
7.1 Inspection before commissioning	-----	16
7.2 Introduction to controller panel	-----	16
7.2.1 Introduction to Hanli split controller panel	-----	16
7.2.2 Introduction to Jingchuang split controller panel	-----	17
7.2.3 Introduction to LCD controller panel	-----	18
7.3 Power on display	-----	18
7.4 Temperature display	-----	19
7.4.1 temperature display of integrated controller	-----	19
7.4.2 temperature display of split controller	-----	19
7.5 Parameter setting	-----	19
7.5.1 parameter setting of split controller	-----	19
7.5.2 parameter setting of LCD controller	-----	20

8	Maintenance	20
8.1	Dustproof in summer	20
8.2	Anti-freeze in winter	21
8.3	Routine maintenance	22
9	Fault analysis and troubleshooting	23
10	Circuit diagram	25
11	Transportation and storage	27
11.1	Transport requirements	27
11.2	Storage requirements	27
12	Other instructions	27
12.1	Service support	27
12.1.1	Warranty scope	27
12.1.2	Circumstances beyond the scope of warranty	27
12.2	Other matters	28

foreword

Thank you for your trust in our company and choosing to use our company's fiber laser chiller. In order to enable you to better understand and use our company's products, to make them play the best effect, and to provide you with perfect after-sales service, we sincerely welcome you to Read this manual carefully before use, and consult this manual if you have any doubts during the use of the product.

This manual is prepared for the owners and users of the chiller. It includes product performance parameters, appearance and component names, working principle, daily maintenance, fault description and troubleshooting methods, etc., and is used for installation, operation, commissioning and maintenance.









This manual is not a quality assurance document, and the printing corrections, revisions of product information, and product improvements are the final interpretation of the company without prior notice, and the updated content will be compiled into the reprinted manual. If you have any questions about the use of the product or suggestions for improvement, please contact our service personnel

Warning notices





In order to ensure your personal safety and avoid property damage, you must pay attention to the warning notices in the company's manual. The warning is based on the risk level from highest to lowest and is listed below, but not limited to the following. General knowledge of electricity use and safety regulations should also be followed.

 **Dangerous** Be sure to take safety measures, otherwise it will lead to death or serious personal injury.

Warning tips	Warning signs	Operational specifications
Please be operated by technical personnel with professional		Handling, installation of piping, electrical, operation, maintenance, maintenance and other operations, must be carried out by personnel with professional knowledge.

knowledge	Must be implemented	
High Voltage Risk		Contact with live parts can result in serious personal injury or death.
scald burn risk		Any part of the body and heat resistant articles must be kept away from this high temperature area, otherwise it will cause personal injury or property loss.
Electrical connections	 Must be implemented	A) The power supply mode must be selected in accordance with the relevant contents of the nameplate or the manual; B) The cable must use standard cable, and the wire diameter shall be selected according to the standard; C) Grounding must be installed and the connection must be reliable, otherwise it will cause the danger of electric shock or fire.
Maintenance	 Must be implemented	It must be cut off for 3 minutes before it can work.
Scrap	 Must be implemented	When the equipment has reached its service life and needs to be scrapped, it must be disposed of with industrial garbage. Please ask professional guidance for scrapping.
Do not use beyond specification	 Prohibited 禁止	It is forbidden to use the equipment beyond the specification in order to avoid major accidents such as equipment damage, injury, fire and electric shock.
Cannot be used in an explosive environment	 Prohibited 禁止	Do not install in a dangerous place where there is combustible gas.
Do not run the device without an outer cover	 Prohibited 禁止	There are live parts in the machine. Do not run without an outer cover Danger of electric shock.
Waterproof	 Prohibited 禁止	Do not let the equipment drench or soak, otherwise there may be short circuit and electric shock hazard.





Warning Be sure to take safety measures, otherwise it may lead to death or serious personal injury.







Warning tips	Warning signs	Operational specifications
Transport, installation	 Must be implemented	When the equipment is transported and installed, the equipment must be fixed firmly, otherwise there is a risk of overturning and falling.
Electrical protection	 Must be implemented	Power cable access terminal must match the leakage and overload protection device according to the rated current indicated on the equipment nameplate.
Discontinue operation immediately when abnormal occurs	 Must be implemented	When the equipment is abnormal, as long as the cause is not clear, it is forbidden to start, otherwise there will be damage, electric shock, fire, injury risk.
Do not extend fingers and foreign objects into the gap of the equipment	 Prohibited	The equipment is equipped with rotating parts. When the equipment is running, it is forbidden to put fingers or foreign bodies into the gap of the equipment, otherwise it will cause personal injury.
Refrigerant leakage	 Must be implemented	a) When refrigerant leakage occurs, please be sure to get some air and ventilation. Otherwise a large amount of refrigerant filled with closed space, will produce anesthesia to the human body and cause asphyxiation risk; b) Avoid contact with the skin, otherwise it will frostbite.



Notice

Please take safety measures, otherwise it may lead to minor personal injury and property loss.

Prompt item	Warning signs	Operational specifications
Prohibition of liquid transport	 Prohibited	The equipment is forbidden to carry liquid to prevent internal pipeline leakage.
Handling	 Must be implemented	a) Equipment should be fixed before handling to prevent equipment movement caused by vibration and external force. If there is excessive vibration and external forces, the internal equipment is at risk of damage; b) Keep the tilt angle $\leq 45^\circ$, otherwise the refrigeration system will fail.
Operating environment	 Prohibited	a) Prohibit the use of high temperature, humidity, strong electromagnetic interference and other special environments; b) Equipment must be installed in places without direct sunlight and away from fire sources.
Installation	 Must be implemented	a) Equipment must be installed horizontally, otherwise the refrigeration system will fail; b) Items are prohibited within 1.5 meters around the suction

	Must be implemented	port and 2.0 meters around the outlet. If suction and exhaust are obstructed, the cooling capacity of the equipment cannot be used.
Before trial operation	 Must be implemented	a) Need to ensure that the equipment side water supply pipe is not obstructed; b) Need to check the water pipe and pump, confirm that there is a proper amount of water into the pump, and the exhaust is through the pump exhaust valve, otherwise it will cause damage to the pump; c) Confirm the condition of the equipment is normal and safe, otherwise there may be injury and breakage.
Equipment no stampede	 Prohibited	Please don't step on the equipment or sit on it, otherwise it will cause the injury accident of falling.
Regular cleaning of air filters	 Must be implemented	Clean the air filter at least once a week. If the air filter is obstructed, the refrigeration capacity will be reduced, the power consumption will increase, and even the alarm will not work properly.
Keep surface clean	 Must be implemented	a) Use non-corrosive cleaning agents for metals and plastics; b) After cleaning, please take good care of the cleaning agent to prevent liquid leakage anywhere in the equipment; c) Containers that store detergents should be completely sealed to avoid danger.
Wear protective gloves for maintenance, repair and cleaning	 Must be implemented	a) The sharp edge of the condenser fin is dangerous to cut the skin; b) Internal compressor and refrigerant pipe temperature is very high, direct contact with the skin has the risk of scalding.
Anti-freezing	 Must be implemented	If the ambient temperature is lower than 0°C and the shutdown is long, the liquid should be discharged. Moreover, use compressed air to clean the water in the system, otherwise there is a risk of frostbite components and pipes.

1 overview

This product is a cooling device designed and manufactured for laser cutting, laser welding, laser engraving, laser marking, laser printing, etc. Coolant, to cool down the fiber laser, the other is normal temperature coolant, Cool down the fiber laser cutting head.

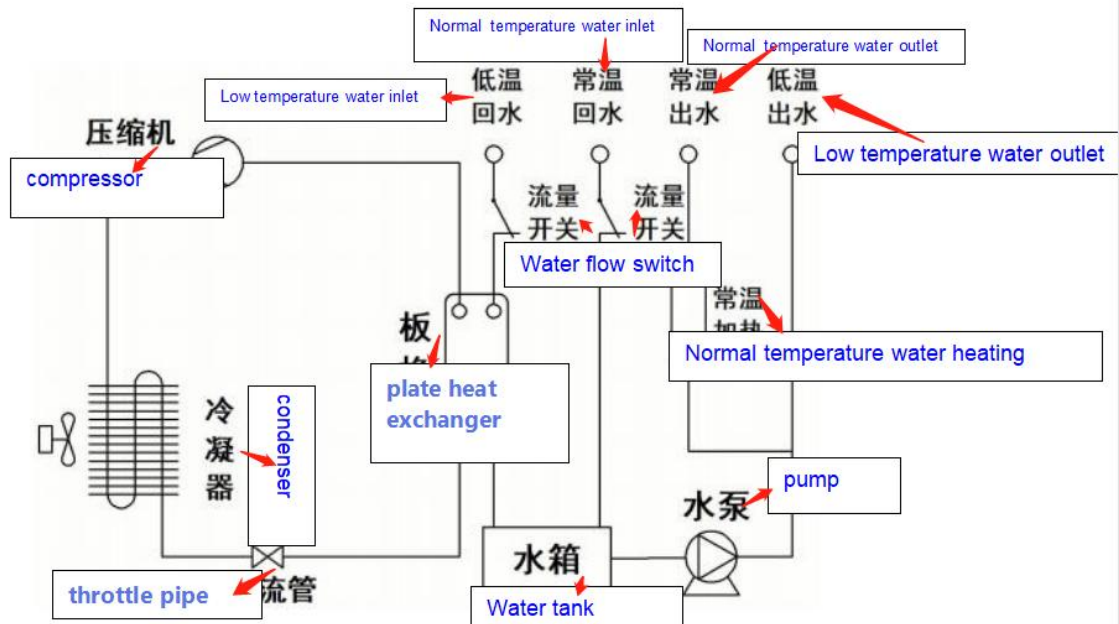

Figure 1 System composition and working principle of chiller

The chiller is composed of a compressor, a condenser, a throttling device, an evaporator, a water tank and a water pump, etc.

Its working principle is that the compressor compresses the superheated steam sucked from the evaporator into a high-temperature and high-pressure gas, and discharges it to the condenser to condense and release heat into a high-pressure liquid. The low-temperature and low-pressure super cooled liquid is vaporized by the evaporator to absorb heat into superheated steam, and then returns to the compressor to enter the next cycle to realize the refrigeration function. The heat absorbed by the vaporization of the evaporator comes from the cooling medium, and the temperature of the cooling medium will decrease. The low-temperature coolant is divided into two by the water pump and pressed out. One path of low-temperature coolant cools down the laser, and the other path is heated by a heating device to become a room-temperature coolant for the laser. The cutting head cools down.

2 Conditions of use

2.1 Environmental requirements

- Ambient temperature: 0 ~ 45°C;
- Relative humidity: ≤90%;
- Altitude: ≤3000m;
- The relationship between the temperature of the cooling medium and the ambient temperature is shown in Figure 2.

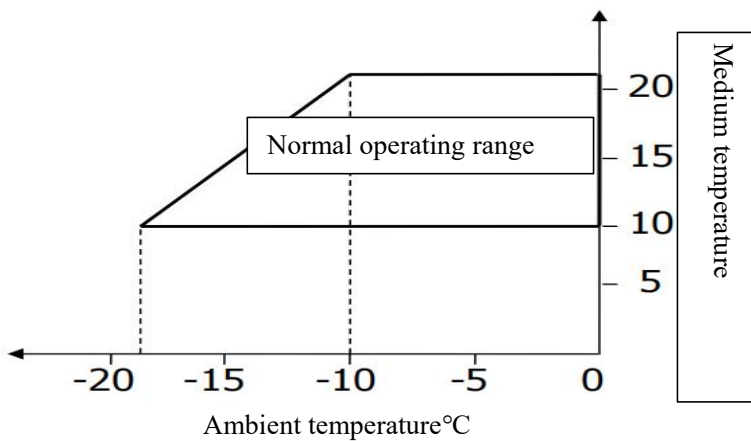
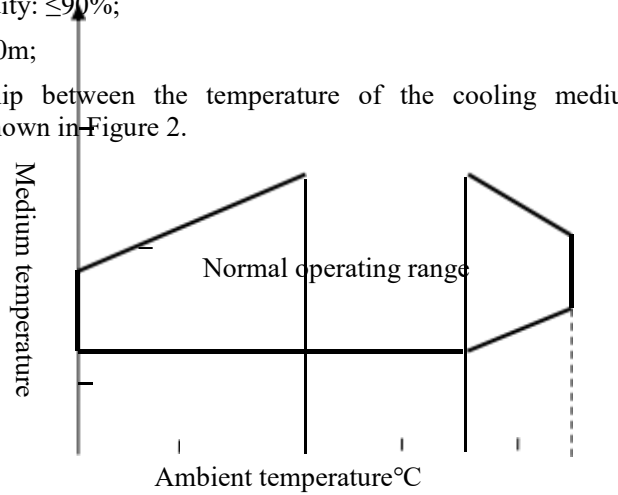

FIG. 2 Operation range of equipment

Note: The above operating range is obtained in the laboratory according to the standard product test, for reference, the operating range of each specific model may be slightly different, please contact the manufacturer for details.

2.2 Medium requirement

The cooling medium must be softened water, such as pure water, distilled water, high-purity water, etc. It is allowed to add ethylene glycol with a volume ratio of $\leq 30\%$, or ethanol with a volume ratio of $\leq 20\%$, and it is allowed to add preservatives and bactericides approved by the manufacturer.

It is strictly forbidden to use antifreeze with a volume ratio greater than 30%, oil and oil-based liquids, flammable and explosive liquids, liquids with solid particles, and liquids corrosive to aluminum and stainless steel are strictly prohibited.

3 Model description

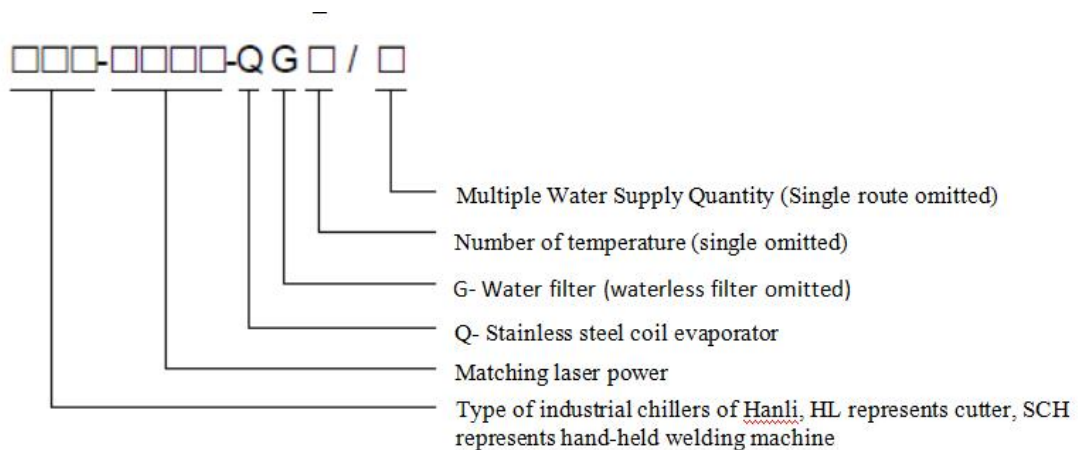

For example, HL-3000-QG2 /2 represents a laser cutting machine with a matching laser power of 3000W, which adopts a stainless steel coil evaporator, waterways are equipped with water filters, and double temperature and two channels of water supply.

For example, SCH-1500 represents a handheld welding chiller with a matching laser power of 1500W, which is equipped with a water filter by default, and double temperature and two channels of water supply.

Note: This Model description is our company's standard product code description, does not list all models, please confirm with our company before ordering of specific models. If there is change, without notice.

4 Performance parameters

No.	Equipment model	Power supply	Power (kW)	Coolants	Freon injection (kg)	Lift (m)	Rate of flow (m ³ /h)	Weight(kg)	Equipment size (mm)	Water volume (L)
1	HL-1000-QG2/2	220V 50Hz	2.7	R32	0.28	44	2	41	590×470×750	16
2	HL-1500-QG2/2	220V 50Hz	2.8	R32	0.28	51	2	48	590×470×805	16
3	HL-2000-QG2/2	220V 50Hz	3.0	R32	0.32	51	2	51	610×570×810	16
4	HL-3000-QG2/2	220V 50Hz	3.8	R32	0.4	47.5	3	65	655×535×950	21
5	HL-4000-QG2/2	380V 50Hz	8.5	R32	0.73	62	4	93	750×610×1070	42

6	HL-6000-QG2/2	380V 50Hz	10	R32	0.8	62	4	102	750×610×1070	42
7	HL-8000-QG2/2	380V 50Hz	19	R32	1.3	58.5	10	137	930×790×1250	70
8	HL-12000-QG2/2	380V 50Hz	18	R410A	3.3	58.5	10	186	1170×787× 1495	90
9	HL-15000-QG2/2	380V 50Hz	28	R410A	1.9*2	65	12	257	1540×730× 1120	115
10	HL-20000-QG2/2	380V 50Hz	32	R410A	2.7*2	65	12	315	1700×765× 1135	140
11	HL-30000-QG2/2	380V 50Hz	35	R410A	2.4*3	60	20	500	2250×1000× 1365	200
12	HL-40000-QG2/2	380V 50Hz	44	R410A	2.35*4	86	20	710	1875×1480× 1600	310
13	HL-50000-QG2/2	380V 50Hz	49	R410A	/	60	32	950	2225×1680× 2165	350
14	SCH-1500	220V 50Hz	2.1	R32	0.27	20.5	2	41	760×485×430	13
15	SCH-2000	220V 50Hz	2.5	R32	0.36	27.5	2	43	760×485×430	13
16	SCH-3000	220V 50Hz	3.9	R32	0.53	51	2	60	850×485×577	13
17	SCL-1500	220V 50Hz	2.1	R32	0.27	25	1	30	970×422×435	13
18	SCL-2000	220V 50Hz	2.5	R32	0.35	30	1.2	30	970×422×435	13
19	SCL-3000	220V 50Hz	3.9	R32	0.52	51	1.8	45	1060×522×500	13
20	SCHYTJ-1500	220V 50Hz	2.4	R32	0.35	44	1.2	60	985×420×710	13
21	SCHYTJ-2000	220V 50Hz	2.5	R32	0.33	44	1.2	60	985×420×710	13
22	SCHYTJ-3000	220V 50Hz	3.9	R32	0.6	51	1.8	98	1110×530× 1060	13
23	SY-1500	220V 50Hz	2.4	R32	0.3	44	1.2	74	945×540×930	16
24	SY-2000	220V 50Hz	2.5	R32	0.3	44	1.2	76	945×540×930	16

Note: The above table is part of the standard product performance parameters, for reference only. If there is change, without notice.

5 Appearance and part name

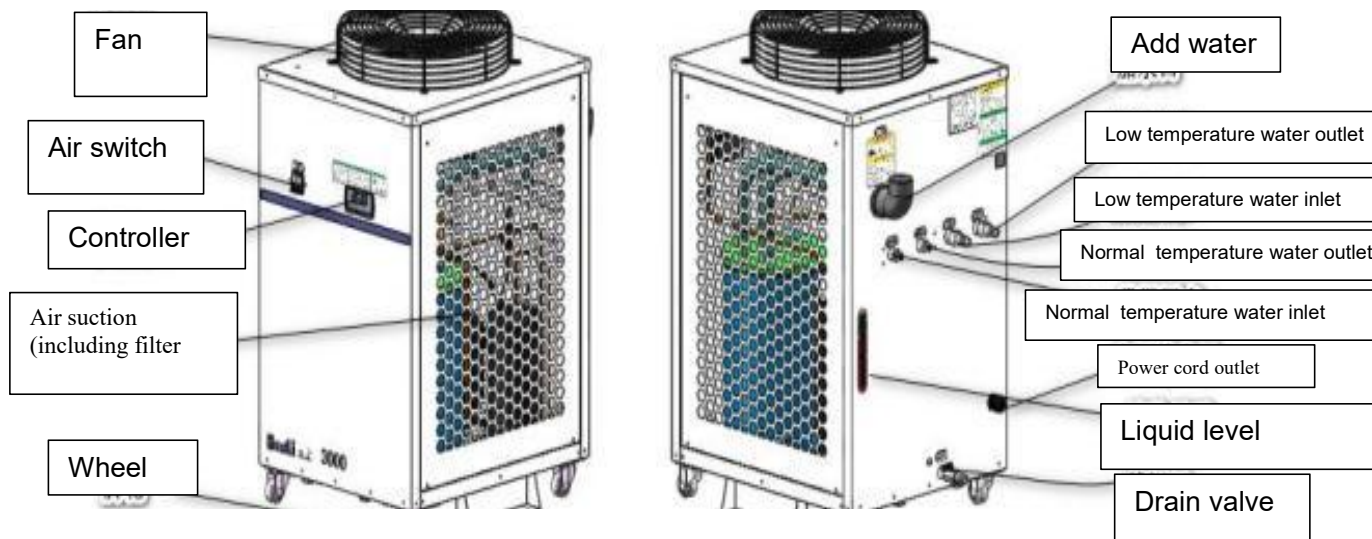

Note: the appearance and part name above are only one of the models. The appearance and part name of different models may vary slightly.

6 Installation

6.1 Installation conditions and requirements

- Open the package and check whether the equipment is in good condition and the attachment list is complete.
- ➤ It must be installed horizontally and cannot be tilted, as shown in FIG. 3. Anchor bolts shall be used to fix casters-free equipment, and universal wheels shall be locked for equipment with caster.
- No shielding shall be allowed in the air inlet within the range of 1.5m and the air outlet within the range of 2.0m, so as not to affect the heat dissipation of the equipment, as shown in Figure 4.
- Products shall not be installed in corrosive, inflammable gas, heavy dust, oil mist, metal and other conductive dust, high temperature and humidity, strong magnetic field, direct sunlight and other harsh environments, as shown in Figure 5.

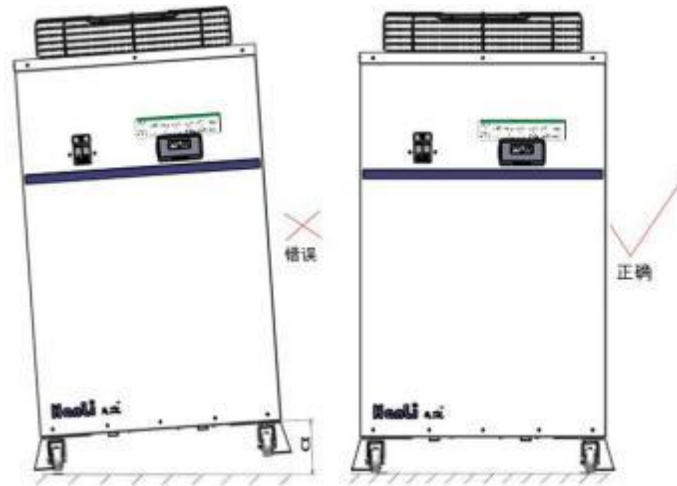

FIG. 3 Requirements for equipment installation form

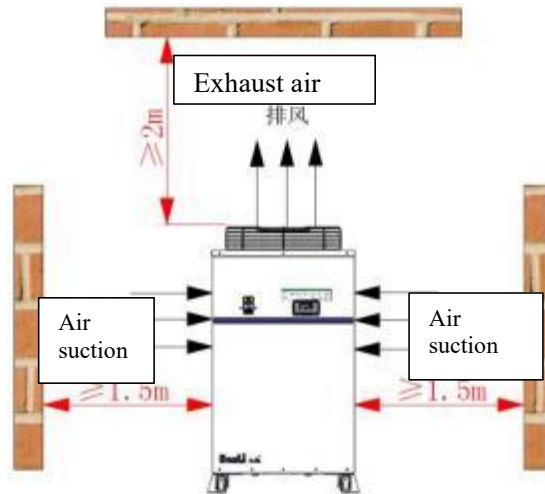

FIG. 4 Equipment installation space requirements

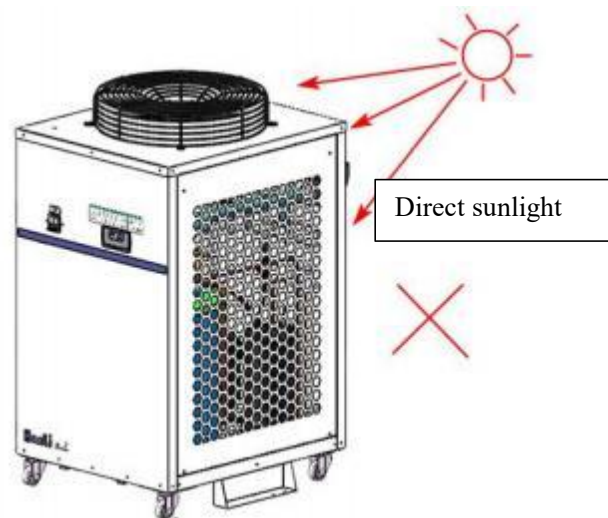

FIG. 5 Environmental requirements for equipment installation

6.2 Waterway connection

- Determine the piping layout direction according to the equipment import and export label, in case the equipment cannot run normally.
- The pipeline should be cleaned during internal construction to strictly avoid impurities. Once impurities enter the system, it is easy to reduce the cooling capacity and may cause faults of the water pump or refrigeration system.
- Pipe connection: The connection method between the chiller and the laser is shown in FIG. 6. The inner diameter of the distribution pipe shall not be less than the diameter of the inlet and outlet of the chiller.
- Pipe resistance: The connection pipe between equipment should be the shortest distance, avoid right Angle and bending, the total pressure drop $\leq 0.05\text{mpa}$.
- If metal lines are used, insulation measures should be taken to prevent energy loss.
- Pipeline pressure must reach more than 1.5 times of water pump supply pressure.

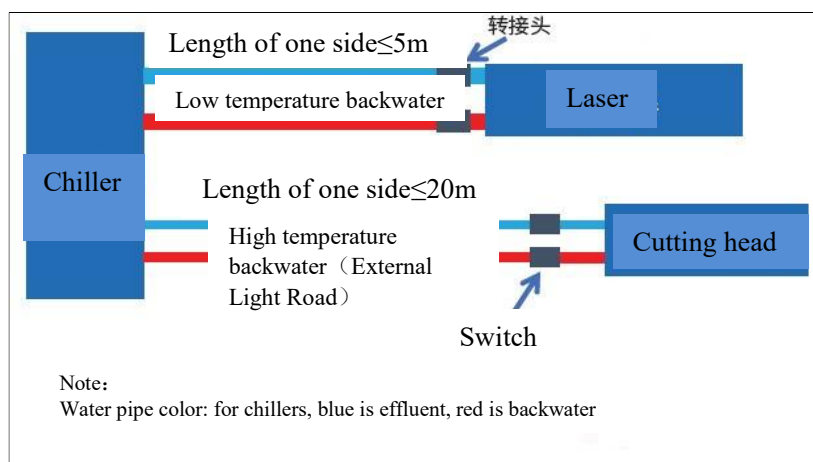

Fig.6 Connection diagram of chiller and laser

6.3 Circuit connection

1. Please refer to the wiring label of the chiller when wiring.
2. Recommended reference standard for power cord diameter selection.

Rated current / A	≤5	≤10	≤15	≤25	≤35	≤50
Power line diameter (copper wire)/mm ²	1.0	1.5	2.5	4.0	6.0	10.0

- ◇ This data is provided in accordance with IEC 60204-1, for reference only.
 - ◇ The power cord must use standard cable.
 - ◇ Rated power refer to chiller nameplate.
- 3.The main circuit of power supply must be installed with appropriate leakage and overload protection devices, and ensure the chiller is well grounded.
 - 4.The allowable fluctuation of power supply voltage is less than $\pm 10\%$ and frequency fluctuation is less than $\pm 1\text{Hz}$, and it should be far away from the electromagnetic interference source.
 - 5.Connection of signal terminals: output passive dry node signals for traffic alarm and over temperature alarm.

6.4 Add water and exhaust air

6.4.1 Add water

Add softened water through the water inlet of the equipment to the standard liquid level area (green area), as shown in Figure 7.

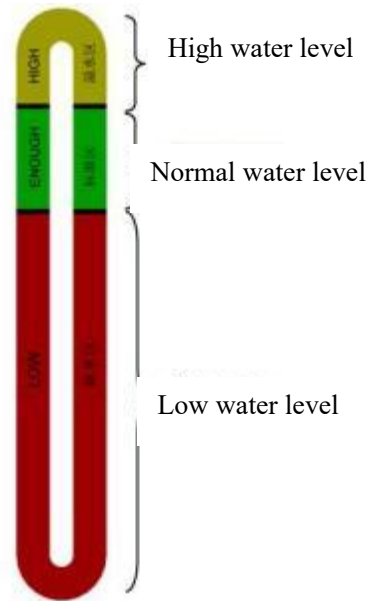

Figure 7 Liquid level identification

6.4.2 Exhaust and drainage

After the first addition of water and replacement of new water, exhaust the air in the pump to start the use, otherwise it will damage the equipment. Exhaust method: slowly loosen the air-exhaust screw plug of the pump (do not screw off), discharge air until water flows out, and then tighten the air-exhaust screw plug (see Figure 8, in which only the exhaust positions of vertical pump and horizontal pump are shown. According to customer requirements and specific type, the pump will be different, exhaust location will also be different, and details can be seen in the pump external indicator). Note: When the liquid in the equipment needs to be drained in winter, loosen the water-exhaust screw plug below to drain the liquid.

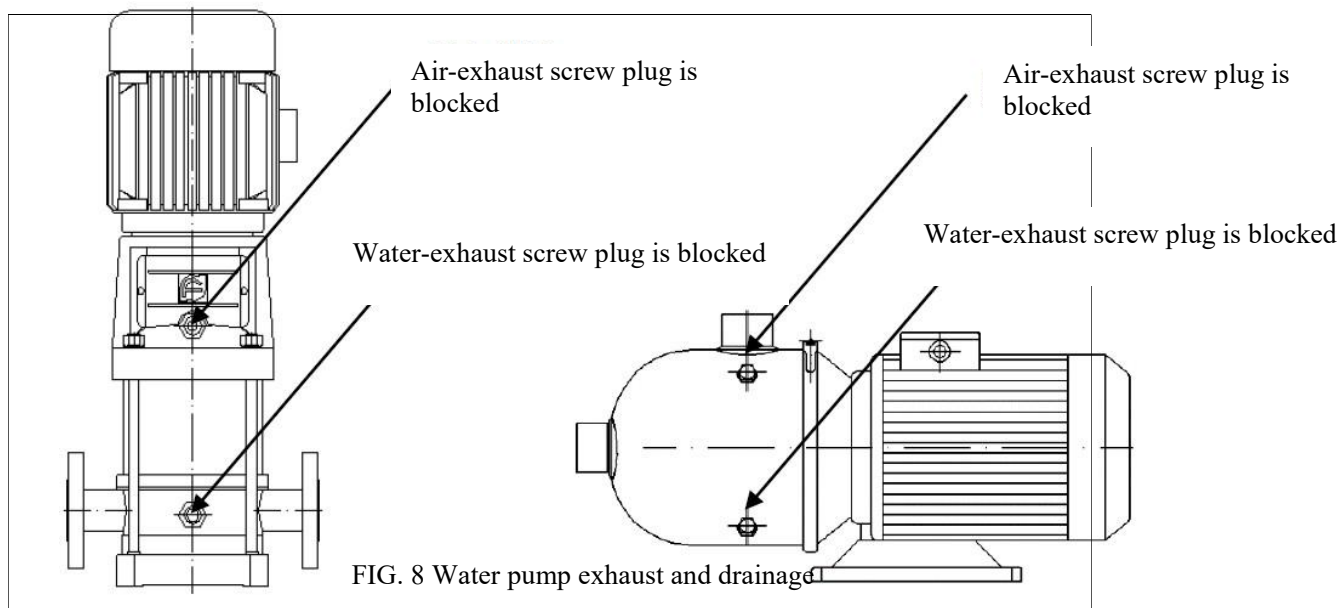

FIG. 8 Water pump exhaust and drainage

6.5 WARM PROMPT

After the equipment is powered on and the water pump is running for a period of time, continue to add water to the water tank to the standard liquid level area.

7 Product use

7.1 Inspection before commissioning

- Check that the inlet and outlet ball valves are open and that the drain valve is closed;
- Check that the water connections are correct and not loose and that there must be no bubbling or leaking;
- Check that the water tank level is in the standard zone;
- Verify that the power supply form matches the product nameplate, the 380V power line is three-phase and five-wire, and that the 220V power supply, The line is a single-phase, three-wire system;
- Verify that the equipment is earthed;
- Verify that the electrical wiring between the equipment is correctly connected.

7.2 Introduction to controller panel

At present, there are three types of controllers for Hanli fiber laser chillers, most of which are split digital tube controllers, as shown in Figure 8 and Figure 9, while a few models use LCD controllers as shown in Figure 10.

7.2.1 Introduction to the Hanli split controller panel

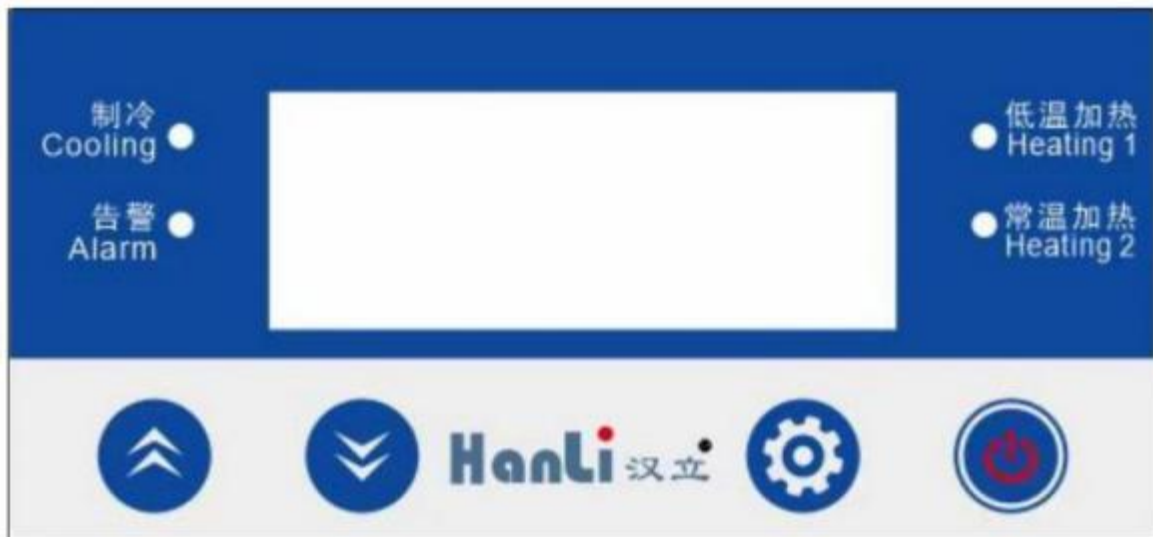

Figure 8 Hanli split controller panel

7.2.2 Introduction to the Jingchuang split controller panel



Figure 9 Jingchuang split controller panel

Digital tube	Uses
Display window	Display of measured temperature (low temperature water L.xx.x / normal water H.xx.x), set temperature display (low temperature water S.xx.x / normal water d.xx.x), alarm code (Exx), parameter code (Fxx).
Indicator light	Uses
Compressor	Illuminated: compressor operating; flashing: cooling demand Off: compressor off.
Low temperature water heating (Heating1)	Illuminated: low-temperature water heating active; extinguished: low-temperature water heating off.
Ambient water heating (Heating2)	Illuminated: ambient water heating active; extinguished: ambient water heating off.
Fault indication (Alarm)	Blinking: faulty; off: no fault
Keystrokes	Uses
On/Off key (On/Off)	Press the <On/Of> key for 3 seconds to switch the power on or off
Set key (Set)	In the non-fault state, press <Set> to enter/exit the set temperature.
Up/down keys (▲ ▼)	During the setting of the parameters , the parameter values are modified.

7.2.3 Introduction to the LCD controller panel





Figure 10 LCD controller panel

Number Management Code	Uses
Real Time Temperature (PV)	Display of "actual measured water temperature, alarm code".
Set temperature (SV)	The "set temperature" is displayed.
Indicator light	Uses
Compressor	Illuminated: compressor on; machine off. Blinking: cooling demand but no press yet Off: compression
Pump	Illuminated: pump on; extinguished: pump off.
Heat	Illuminated: heating on; extinguished: heating off. <i>Switching to the low temperature water interface indicates low temperature water heating, switching to the ambient water interface indicates ambient water heating</i>
Solenoid valves (Valve)	Does not work
Remote	Illuminated: remote switch closed; extinguished: remote switch disconnected.
Run (Run)	Illuminated: unit working; Blinking: unit in anti-freeze mode Extinguished: unit stopped
Fault indication (Alarm)	Blinking: faulty; off: no fault
Keystrokes	Uses
On/Off key (On/Off)	Press the <On/Of> key for 3 seconds to switch the power on or off.
Set key (Set)	In the non-fault state, press <Set> to enter/exit the set temperature.
Up/down keys (▲ ▼)	During the setting of the parameters , the parameter values are modified.

7.3 Power on display

When the split controller unit is powered up, the display shows the software version information (Fxx/v100 /A00) and after approx. 7seconds it enters the temperature display.

When the LCD controller is in the main interface, press  for 3 seconds to switch on the machine, the status bar of the main interface will show "Running" after switching on the machine; press  again for 3 seconds to switch off the machine, the main interface will show "Stop" after switching off the machine.

7.4 Temperature display

7.4.1 Split controller temperature display

The display shows the measured water temperature (L.xx.x) for low temperature water by default.

When the temperature is displayed, press <▼> to switch between the display of the measured water temperature (H.xx.x), the set water temperature (S.xx.x) and the set temperature difference (d.xx.x) for normal water, and return automatically after 30 seconds without switching.

Back to the low temperature water interface.

[Note]: L./H./S./d. is the temperature code, xx.x is the temperature value.

7.4.2 Integrated controller temperature display

The PV zone shows "actual temperature" and the SV zone shows "set temperature".

7.5 Parameter setting

7.5.1 Parameter setting of the split controller

In the non-fault state, press <▲>+<▼> at the same time to enter the low temperature water setting temperature setting interface, the setting temperature xx.x is displayed flashing, at this time the setting temperature can be modified by pressing <▲> or <▼> keys.

If no key operation is performed for 5 seconds after setting, the system will automatically save the set value and exit the setting state.

Normal water set temperature = [Low temperature water set temperature] + [F01 Normal water temperature difference], to change this ,you need to modify the factory parameter [F01 Normal water temperature difference].

In the temperature display, press the <▲>+<▼> keys simultaneously for 5s to enter the manufacturer's parameter setting status, the factory set parameters are generally not adjusted, if you need to adjust, please seek the chiller manufacturer's agreement.

During the selection of the manufacturer's parameters, press <▼> to select the parameter item, press <▲> to enter the parameter setting and exit the manufacturer's parameter setting after 15s of operation without pressing the key (the display shows the parameter item).

For parameter setting, the parameter value can be modified by <▲> or <▼>, after 5S of keyless operation or by pressing <▲>+<▼> to return to the parameter selection and save (the display flashes to show the parameter value).

7.5.2 LCD controller parameter setting

Blow it with compressed air

change of set temperature

Wash and dry

If the user parameter [Lock Temperature] is set to "No", the set temperature can be changed directly in the main interface.

degrees, operating as follows:

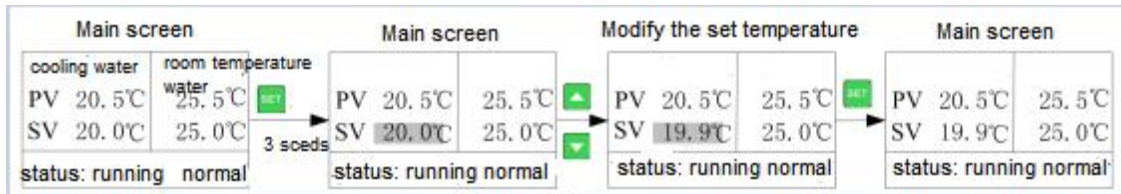

[Remark 1]: The set temperature can also be modified in the user parameters.

[Note 2]: When changing the set temperature in dual temperature mode, press the  key to switch between low temperature water/ambient water

Set the temperature.

②、Inquiry/Reset Fault

When a fault occurs, an alarm appears in the main interface and the fault is queried and reset as follows:

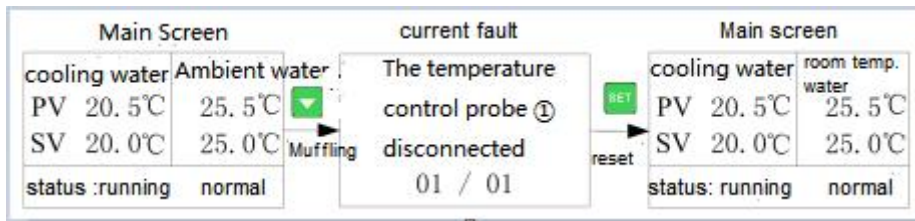

8 Maintenance

The equipment must be stopped and cut off after 3 minutes for maintenance, otherwise there is a risk of electric shock. When the ambient temperature is below 2°C, the internal water must be drained when the machine is shut down for a long time.

8.1 Dust control in summer

During the summer months, please dust and clean the condenser and dustscreen of the equipment in about 15 days, as shown in Figure

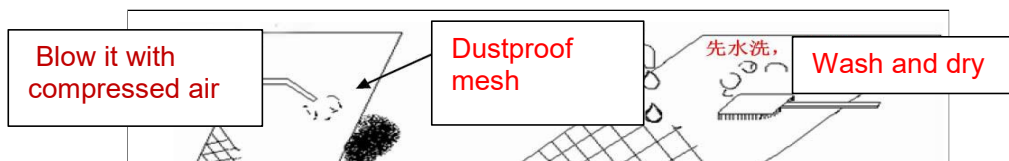

Figure 11 Dust screen cleaning and dust removal process

8.2 Winter frost protection

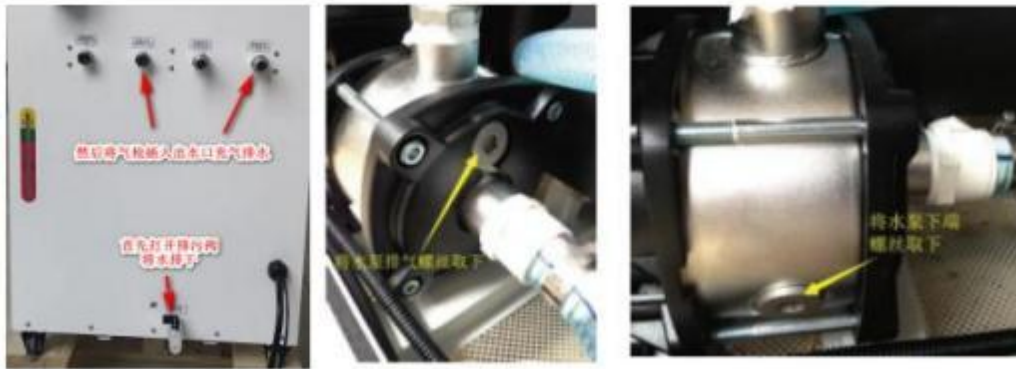

Fig. 12 Winter frost protection maintenance

When the appliance is in transport or not in use for a long period of time, the water in the tank should be drained through the drain valve and the remaining water in the pump should be drained by loosening the drain screw plug under the pump, as shown in Figure 12.

If the ambient temperature is below 2°C at night, the customer is advised not to stop or to add antifreeze. The glycol volume ratio is selected according to Table 1 and the freezing point prevented is equal to the ambient temperature at which the equipment is located minus approximately 5°C. When the average daily temperature is above 5°C, replace the water containing the antifreeze with softened water.

Table 1 Correspondence between different volume ratios of ethylene glycol and freezing point

Volume ratio/%	Freezing point/°C	Volume ratio/%	Freezing point/°C	Volume ratio/%	Freezing point/°C
1.8	-0.6	26.0	-13.0	51.9	-41.0
3.6	-1.3	28.0	-15.0	53.9	-44.0
5.4	-2.0	29.9	-17.0	56.0	-48.0
7.2	-2.7	31.9	-18.0	78.9	-47.0
9.1	-3.5	33.8	-20.0	81.0	-43.0
10.9	-4.4	35.8	-22.0	83.1	-40.0
12.8	-5.3	37.8	-24.0	85.2	-36.0

14.6	-6.3	39.8	-26.0	87.3	-33.0
16.5	-7.3	41.8	-28.0	89.4	-29.0
18.4	-8.0	43.8	-31.0	91.5	-26.0
20.3	-9.0	45.8	-33.0	93.6	-23.0

22.2	-11.0	47.8	-36.0	95.8	-19.0
24.1	-12.0	49.8	-38.0	100	-13.0

8.3 Daily maintenance

In order to ensure the good performance of the equipment and to prolong its service life, it is necessary to carry out maintenance on the equipment at a frequency of **once a week**.

- Inspection of the condenser, checking that the air ducts are not blocked by foreign objects and that the incoming and outgoing air around the equipment is clear;
- Cleaning of the condenser and cleaning of dust screens;
- Check the cooling medium for foreign objects, microorganisms, etc., and replace the cooling medium **in 15-20 days**. the cooling medium must be **pure, distilled or high purity water**;
- Checking water connections for looseness and pump leaks;
- Inspection of the water tank and cleaning of the dirt deposited inside the tank;
- Regularly clean the filter in the waterway of the equipment, generally **7~10 days** to clean the filter, the company commonly used of filters, as shown in Figure 13, with the Y-filter placed at the suction of the pump or at the outlet of the equipment;
- Testing insulation resistance, insulation resistance $\geq 5 \text{ M}\Omega$;
- Check earth resistance, earth resistance $\leq 4\Omega$;
- Capacitance tests are carried out on the capacitors of the compressor and fan. Capacitance decreases of more than 10% require replacement of the capacity

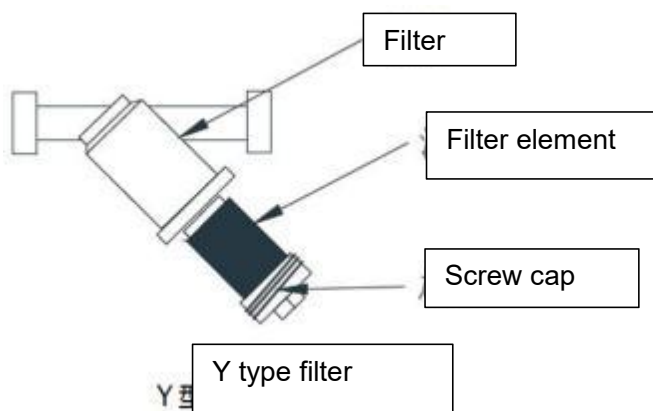

Fig. 13 Filters commonly used in our company

9 Fault analysis and troubleshooting

When the machine detects a fault, the display alternates between the temperature and the fault code "Exx". If there are multiple faults, press <Up> or <Down> to toggle between the different faults, press <Up> or <Down> to fix the fault code and then alternate between temperature and fault code again after 5s. The fault codes and descriptions are listed in the table below:

Table 2 List of fault codes for split controllers

Fault Code	Fault name	Failure analysis	Movement	Exclusion methods
E01	Low temperature water Probe failure	A : Low temperature water probe short circuit / disconnection B : Damaged low temperature water probe	No pump stop, all other outputs stop	A: Check for loose probe wires B: Replacement probe
E02	Low temperature water High temperature alarms	A : Insufficient water flow B : Poor ventilation C : Too much dust	Stop only low temperature water electric heating	A: Testing the water supply line B: Clear the surrounding clutter C: Cleaning dust from the condenser
E03	Compressors Pressure failure	A : Poor ventilation B : Refrigerant leak C : Condensing fan not running D : Too much dust in the filter E : Damaged pressure switch	Stop the compressor, not the pump	A: Clear the surrounding clutter B: Checking for leaks C: Check the fan D: Cleaning the dust E: Check for loose pressure switches and wiring
E04	Phase sequence alarms	A: Power supply out of phase / out of phase B : Phase sequence error C : Three-phase unbalance B : Damaged phase sequence protector	Stop the whole machine	A: Checking the power supply B: Arbitrary pairing of two phase lines C: Checking the power supply circuit D: Replacement of phase sequence protector
E05	Low temperature water Flow alarms	A : Blocked low temperature water line B : reversed inlet and outlet connections C: Leaky suction line D : Damaged flow switch	No pump stop, all other outputs stop	A: Clean the lines B: Check inlet and outlet lines C: Check and tighten the water suction line D: Check flow switch and replace
E06	Water level switch alarm	A : Insufficient water tank level	Stop electric heating of low and normal temperature water	A: Refill (to level standard zone)
E07	Compressor overload	A : Dirty and clogged condenser B: Fluorine leakage C : Blocked air inlet and outlet D : Ring temperature too	Stopping the compressor	A: Cleaning the dust B: Checking for leaks C: Clean up debris around equipment D: Equipment in a well ventilated area

		high		
E08	Low temperature water Low temperature alarm	A : Low water temperature of the equipment	Stop the compressor, not the pump	A: Check the relay for adhesion
E09	Room temperature water Probe failure	A: Ambient water probe short circuit / broken wire B: Damaged ambient water probe	No pump stop, all other outputs stop	A: Inspection of probe terminals and connections B: Replacement probe
E10	Room temperature water High temperature alarms	A : Insufficient water flow B : Poor ventilation	Electric heating of room temperature water only	A: Check if there is a return of water at room temperature and if the water circuit is blocked B: Clear the surrounding clutter
E11	Room temperature water Low temperature alarm	A : Low water temperature of the equipment	Stop the compressor, not the pump	A: Check the relay for adhesion
E12	Room temperature water Flow alarms	A: Clogged normal temperature water line B : reversed inlet and outlet connections C: Leakage in ambient water line D : Damaged flow switch	Stop electric heating of room temperature water	A: Testing the cutting head for backwater B: Check inlet and outlet lines C: Check and tighten water line connections D: Replace flow switch

[Remarks]: For faults requiring manual reset, press <▲> for 3 seconds on the split controller to reset the fault and start automatically when the fault is removed.

Table 3 List of LCD controller fault names

Fault name	Testing conditions	Troubleshooting	Reset
Pressure switch alarms	Press operation [pressure switch alarm delay] Time after detection	Stop all compressors, no pumps	Automatic
Compressor failure	Post-operational compressor test		Manual
Press current too low			Manual
Water pump overload	Post-operation testing of water pumps	Discontinued units	Manual
Pump current too low			Manual
Probe ① Low temperature alarm	Power-up detection	Stop all compressors, no pumps	Automatic

Probe ① High temperature alarm		Alarm, power failure heating ①	Automatic
Probe ② Low temperature alarm		Stop the normal temperature water valve, not the pump	Automatic
Probe ② High temperature alarm		Alarm, power failure heating ②	Automatic
Temperature control probe ① disconnected	Power-up detection	No pump stop, all other outputs stop	Manual
Temperature control probe ① short circuit			Manual
Temperature control probe ② disconnected	Power-up detection	No pump stop, all other outputs stop	Manual
Temperature control probe ② short circuit			Manual
Environmental probe disconnection	Power-up detection	No pump stop, all other outputs stop	Manual
Environmental probe short circuit			Manual
Water flow switch ① alarm	Post-operation testing of water pumps Anti-freeze mode: pump running and delayed [anti Freeze flow detection delay] time after detection	Alarm, power off heating ①, stop all compressors and fans	Automatic
Water flow switch ② Alarm		Alarm, power failure heating ②	Automatic
Water level switch ① alarm	Power-up detection	Alarm, power failure heating ①	Automatic
Water level switch ② Alarm	Power-up detection	Alarm, power failure heating ②	Automatic
Phase sequence alarms	Power-up detection	Discontinued units	Manual
Over-temperature alarm for room temperature electric heating	The machine will start detecting after power up and will be silenced by [temperature ② alarm delay].	Alarm, power failure heating ② Alarm output point for temperature ② Alarm output	Automatic
Unit to be maintained	Post-operation testing of water pumps	The unit cannot be switched on once it has been shut down (the cumulative running time of the unit exceeds over [trial period])	
Please perform equipment maintenance ①	1 test at power-up	Alarm only, does not affect equipment operation If the alarm is not reset manually for more than 20 minutes, it will be reset automatically and will remain on the next power-up; If the fault is manually reset within 20 minutes of the alarm, the maintenance timer will be cleared and the next power-up will not be an alarm.	

10. circuit diagram

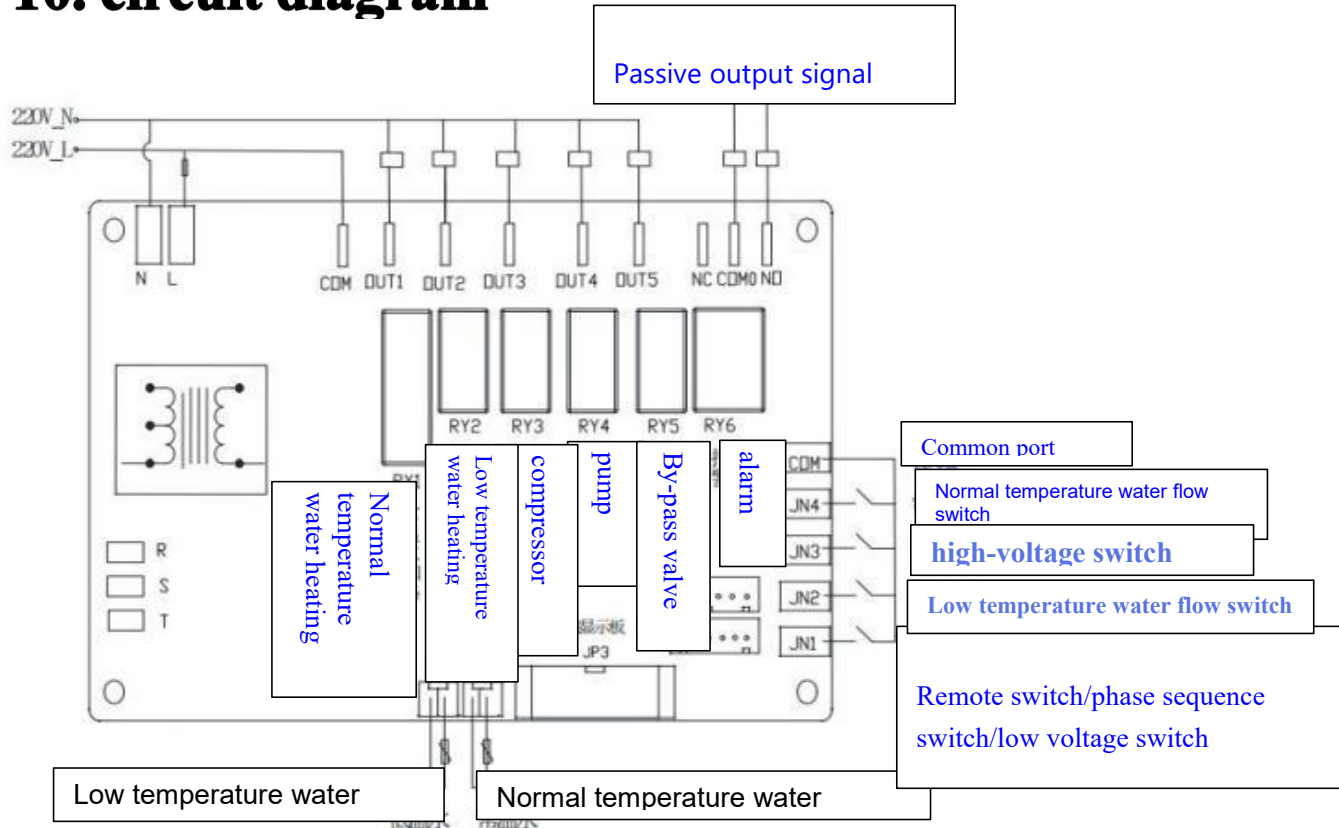

Figure 14 circuit diagram of 380V split controller

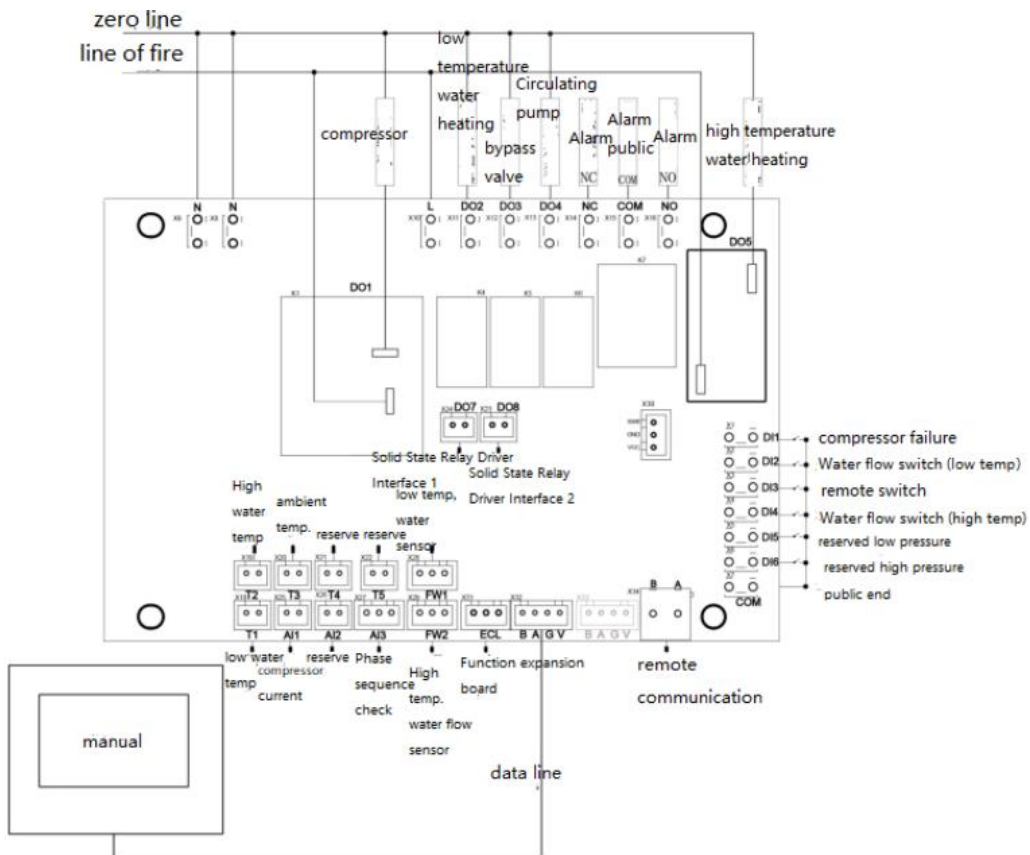

Figure 15 circuit diagram of 220V split controller

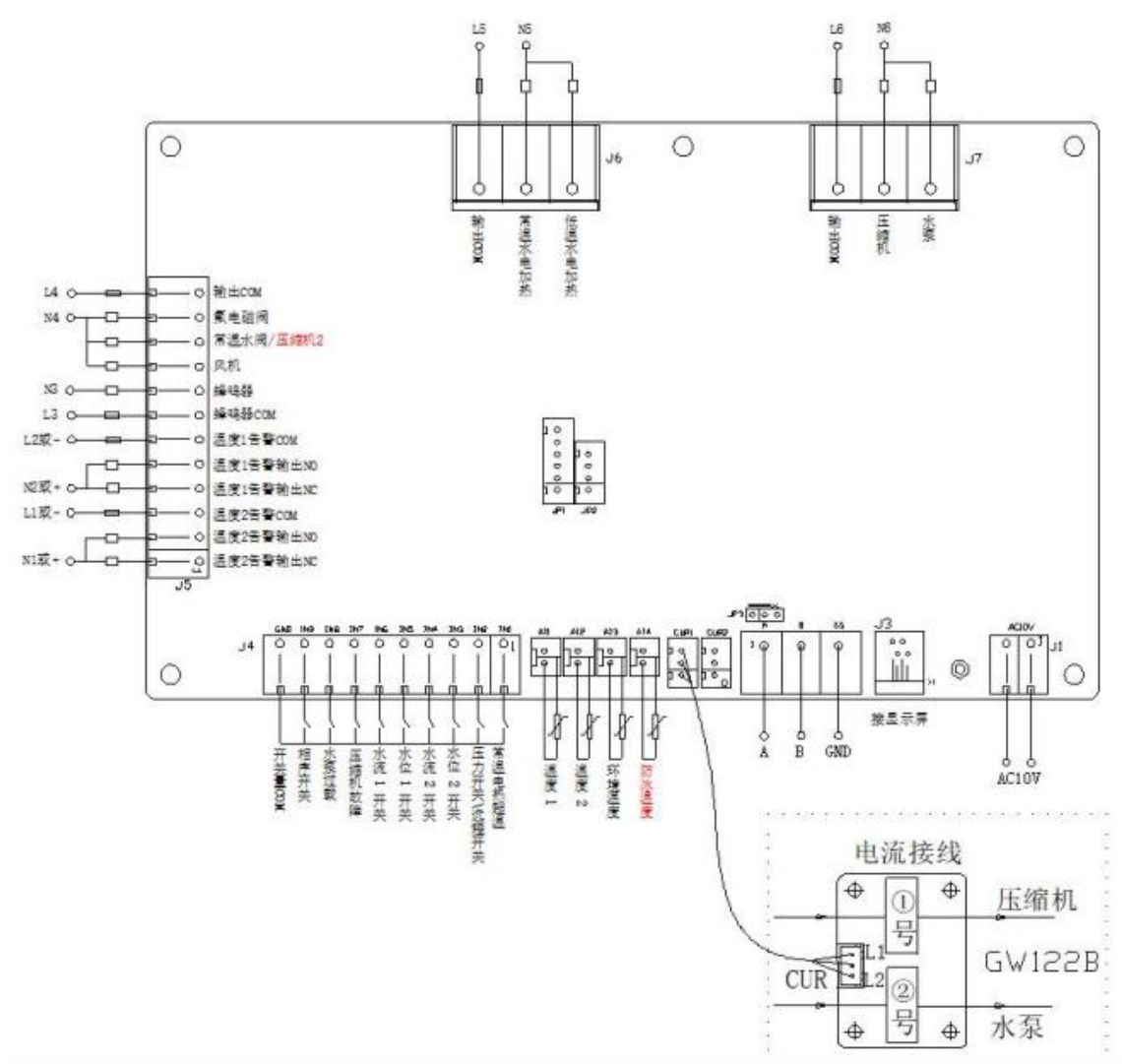

Figure 16 380V LCD controller circuit diagram

11 Transportation and storage

11.1 Transportation requirements

1. When transporting or handling, do not bump or tilt excessively (not more than 45°), avoid bumping, hitting and overturning.
2. When moving the equipment, use the proper tools, such as a forklift or overhead crane, and do not carry the equipment empty-handed.
3. Before moving the equipment, remove the power cord and drain the coolant inside the system, do not move or transport the equipment with liquid.

4. When using a forklift to move the equipment, make sure the equipment is stable and <200mm above the ground, and make sure to avoid the equipment casters.

5. When using an overhead crane to move the equipment, use a wire rope to hold the equipment in a stable position before moving.

11.2 Storage requirements

When the equipment is not used for a long time, please drain the coolant from the equipment and use compressed air to drain the coolant from the pump, filter and pipeline, wipe off the water and oil, pack the equipment with winding film to prevent dust and water, and place it in a cool and ventilated place without direct sunlight and dust gathering.

Storage environment conditions, temperature: 0~60°C, relative humidity: ≤90%.

12. Other instructions

12.1 Service support

12.1.1 Warranty coverage

➤ Within 24 months from the date of purchase of the product from our company, the failure obviously caused by the design defect or quality problems arising from manufacturing, the company provides free repair and replacement parts.

➤ The warranty period expires, lifetime paid maintenance.

12.1.2 Non-warranty range of cases

➤ Not in accordance with the instructions for installation, use and maintenance or use of power and other external conditions do not meet the requirements

➤ Damage caused by the external conditions such as power supply does not meet the requirements.

➤ Damage not caused by our company's poor transportation and storage.

➤ Damage caused by the modification of our products or other human factors.

➤ Damage caused by human force majeure factors. For example: natural disasters, war, etc.

➤ Damage caused by installation on vehicles and ships or use abroad.

➤ Damage caused by equipment failure.

12.2 Other matters

➤ The power supply should be installed according to the national wiring standard specification (voltage, frequency, and differential pressure should be met)

➤ If the power cord is damaged, to avoid danger, it must be replaced by the manufacturer's maintenance department, or professional personnel in similar department to replace.

➤ The power must be turned off for 3 minutes before repairing.