

DDCS V3.1

Standalone Motion Controller Users Manual V3



Software Version No. 2019-04-25-107NOR

All copyrights reserved
Shall not be reproduced without permission.

Contents

1	DDCS V3.1 Controller Brief Introduction	3
1.1	Product Introduction	3
1.2	DDCS V3.1 Brief technical feature	4
1.3	Appearance, Structure and Size of Product	5
1.4	Explanation of Abbreviations	7
1.5	Notes and Warnings	7
2	Wiring	8
2.1	Power supply explanation	8
2.2	Product Wiring Overview	8
2.3	START/PAUSE/ESTOP Switch Wiring	9
2.4	USB Wiring	9
2.5	MPG Port	10
2.6	Main Port Wiring	12
2.6.1	Spindle control output	15
2.6.2	Limit, Home and Probe Inputs, and the Power for the Input	16
2.6.3	Stepper/Servo Control Output	18
2.6.4	Power Supply Input	19
3	Software and Operation	20
3.1	Interface description	20
3.1.1	Main page	20
3.1.2	File Management Page	24
3.1.3	Parameter Page	25
3.2	Definition of Keys	26
3.3	Operation of common functions	28
3.3.1	File Management	28
3.3.2	Running a G code file	31
3.3.2.1	Start running G code	31
3.3.2.2	Breakpoint operation	33
3.3.2.3	Start a G code file from a specific line	34
3.3.2.4	Pause in operation	35

3.3.2.5	ESTOP in operation	35
3.3.2.6	Start/Stop spindle	35
3.3.3	Manually position the machine	35
3.3.3.1	Manual step of the X axis	36
3.3.3.2	Manual continuous operation of the X axis	36
3.3.3.3	Use MPG to operate X axis	37
3.3.4	Main Page Parameter adjustments	37
3.3.4.1	Adjust FRO Value	38
3.3.4.2	Adjust SRO Value	38
3.3.4.3	Adjust SJR Value	39
3.3.4.4	F Value modification	40
3.3.4.5	S Value modification	42
3.3.4.6	Select G coordinate system	43
3.3.5	The 2nd Mode	45
3.3.5.1	Go To Zero	45
3.3.5.2	Zero	47
3.3.5.3	Home	49
3.3.5.4	Probe	51
3.3.5.5	Trial Cutting Function	59
3.5	Software Update	59
3.6	Keyboard Operation Methods	62
4	Parameter Instruction	64
4.1	The detailed definition of parameters	64
4.2	Save the Parameters Setting	73
5	G Code and M Code	75
6	Questions and Answer	81

The copyright of this manual belongs to Shenzhen Digital Dream Numerical Technology Co., Ltd. (herein after referred as Digital Dream Company). This manual and any image, table, data or other information contained in this manual may not be reproduced, transferred, or translated without any prior written permission of Digital Dream Company.

The information contained in this manual is constantly being updated. You can login to the official website of Digital Dream Company www.ddcnc.com to download the latest PDF edition for free.

1 DDCS V3.1 Controller Brief Introduction

1.1 Product Introduction

Thank you for your interest in our standalone motion controller and for taking the time to read this manual.

Digital Dream is a numerical control company specializing in the research, development and production of various CNC (Computer Numerical Control) systems since 2008. Digital Dream aims to combine high quality and high reliability with affordability.

The DDCS is a 3~4 axes motion controller for stepper and servo systems. DDCS V3.1 is updated from DDCS V2.1 on software and hardware. We are very proud of this product, it combines great power with a tiny footprint and is easy to use. After a very short time you will be familiar with the functions and this manual will help you. The highest output pulse per axis is 500KHz. This provides high control precision for stepper motors and servo motors.

The DDCS numerical control system adopts the ARM+FPGA design framework. ARM controls the human-computer interface and code analysis and the FPGA provides the underlying algorithms and creates the control pulse. This guarantees reliable control and easy operation. The internal operating system is Linux based.

The panel layout structure of the DDCS V3.1 is very rational to save space. All operations are controlled by only 17 keys and a comprehensive G code set is supported.

The DDCS can be used for many styles and types of CNC machines. Lathes, Routers, Pick&Place and Mills are just a few examples. The DDCS operates as a Stand Alone system without the need of a computer. This guarantees high precision, accuracy and reliability. The interface, even though very comprehensive, can be learned in a very short time.

1.2 DDCS V3.1 Brief technical feature:

- 1) 16 photoelectric isolated digital inputs,3 photoelectric isolated digital outputs;
- 2) 3.1 Version enhanced Algorithm,support soft interpolation,fixed arc interpolation bug of the old version;
- 3) Analog spindle control 0-10V spindle control (can be modified as PWM output);
- 4) 3-4 axes motor Control.Differential Pulse and direction output signal,Max.500Khz per axis;
- 5) ARM9 main control chip,FPGA core algorithm chip;
- 6) 5 inches TFT screen, resolution ratio: 480x272,17 operation keys;
- 7) The Power Supply for the controller is 24VDC, minimum Current is 0.5A;
- 8) The Power Supply for IO Port is 24VDC,minimum current is 0.5A;By the IO power supply,system already supply the power for IO ports.So no need the external power supply for IO port anymore;
- 9) USB flash disk support for G code file input,no size limited of the G-code file ;
- 10) Support standard MPG;
- 11) Jog function for each axis (continuous, step, defined distance);Customer can define the distance;
- 12) Support the operation of quickly specify the running position;
- 13) Support for “Power Cut” recovery. Data is automatically saved;
- 14) Backlash compensation, Tool compensation

DDCS V3.1 New features compared to previous version:

- 1) Control System Unit is compatible with Metric Units and Imperial Units;
- 2) MPG and extended Keyboard can also control and edit the controller system;
- 3) Add new function of “Try cutting”(handwheel guiding) and “Single-stage processing mode” ;
- 4) 3 kinds Probing Modes:Fixed Position of tool sensor,Floating Position of the tool sensor,Rectangular block Sensor;
- 5) Enhanced the software,added a lot of parameters,Optimal Design and algorithm,makes the new version more strong functions and steady;
- 6) The Option Language of the system is Chinese/English/Russian.
- 7) Version 3.1 cited the new circuit design and metal box,which can avoid the noise a lot.

1.3 Appearance, Structure and Size of Product

The DDCS V3.1 is a small box that can fit in a window of a small control box or control cabinet. Four locking hooks fix this controller from the frame. The dimension you find in Figure 1-1 and Figure 1-2.

The front panel is 191mm*128mm*5mm;

The main body is 191mm*128mm*37mm;

To mount the unit in an equipment cabinet, cut the hole 182.5mm*59mm

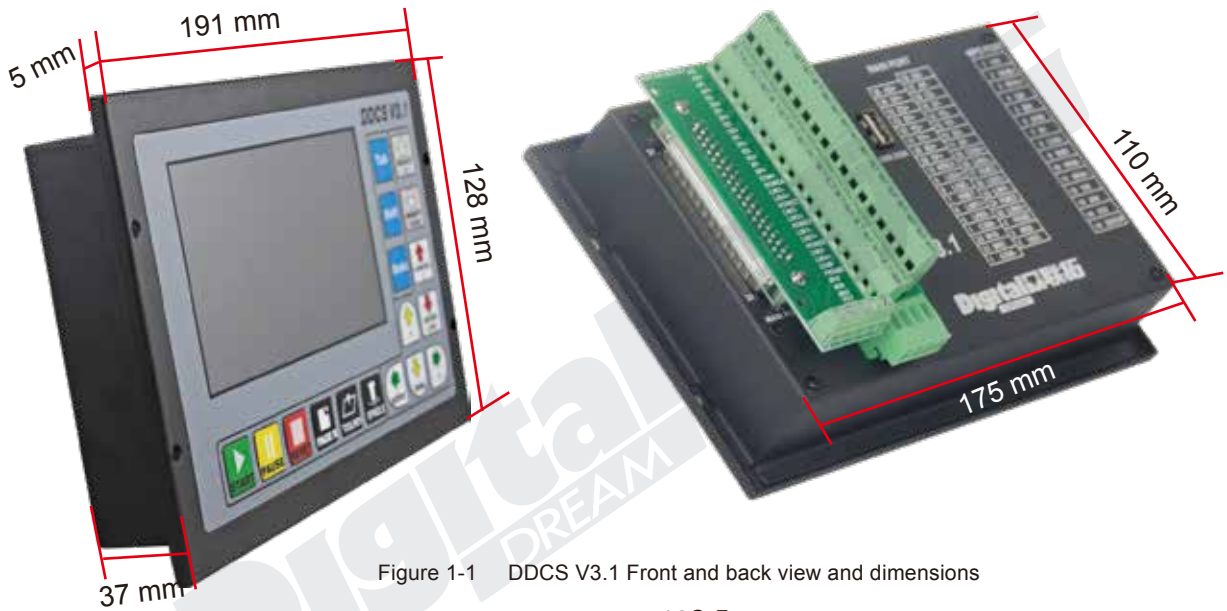


Figure 1-1 DDCS V3.1 Front and back view and dimensions



Figure 1-2 DDCS V3.1 Rear view and dimensions

The front panel consists of 17 user keys and the 5" (480*272) LCD.



Figure1-3 Front panel

At the back side of the controller, there are USB Disk interface, MPG Port, Main Port and external Start/Pause/Estop interface.

For convenient connections we supply a 3 layer wiring terminal for main port.

We also supply a DB-15 Male plug for MPG connection.

The 8 screws are to fix the wiring terminal and controller.

The USB Stick is for the transfer of the G-code file.



Figure 1-4 Back side of the controller and the accessories

1.4 Explanation of Abbreviations

When operating the DDCS, the users will come across some English abbreviations. Here a list with explanations

FRO: Feed Rate Override

SRO: Spindle Rate Override

SJR: Jog Speed Setting

F: Feed rate, unit is mm/min

S: Spindle Speed, unit rev/min.

X: The coordinate code of the X axis.

Y: The coordinate code of the Y axis.

Z: The coordinate code of the Z axis.

A: The coordinate code of the A axis

BUSY: The system is busy. You still can adjust FRO and SRO

READY: READY mode, any operation can be done

RESET: Reset mode, controller is in "OFF" mode, no operation can be performed

CONT: Continuous mode, each axis can be manually jogged with the arrow keys

Step :Manual Step Mode, each axis can be jogged in defined steps

MPG: MPG mode. Operate the machine with the MPG (Manual Pulse Generator)

AUTO: Run G code. Auto is showing when file is processing

1.5 Notes and Warnings



Keep away from exposure to moisture or water. This product contains sophisticated electronics and must not get wet.

Wiring warning: the IO input terminal of this controller supports equipment with source power (such as Inductive Proximity Switch). When using this kind of equipment, pay attention to the polarity. Avoid the +terminal to be connect with GND. This controllers has analog output for spindle control (0-10V). Please avoid this terminal to ever connect with GND as damage to the controller may occur.



Operation warning. Please observe all security measures when operating the machine. The ESTOP must be connected and properly labelled. In case of a problem, press the E-stop at once to avoid damage to humans, animals and the equipment.



High voltage danger. The DDCS is connected to 24V DC. Obey and follow the electricity safety rules of your country when connecting this equipment.

2 Wiring

2.1 Power supply explanation

In general, the power supply of industrial control's equipment products are complex. They have many different ground levels. The internal power structure of this product is as follows:

See Figure 2-1. The Controller need two power supplies, Main power is for system, IO Power is for IO ports. The Main Power input and USB stick and Stepper/Servo Control module share the same ground. IO Power, MPG Port, Spindle PWM, 12 Inputs and 3 Outputs share same ground, between them which is optical isolation. As for the spindle port, take the output ground for references and the 0-10V adjustable voltages to adjust the spindle speed (refer to spindle VFD manual). The M3/M8/M10 digital output ports pull to ground.

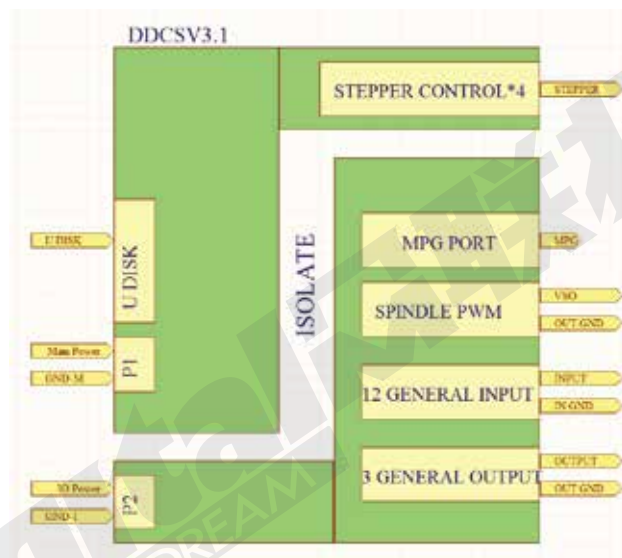


Figure 2-1 Power supply System structure

2.2 Product Wiring Overview

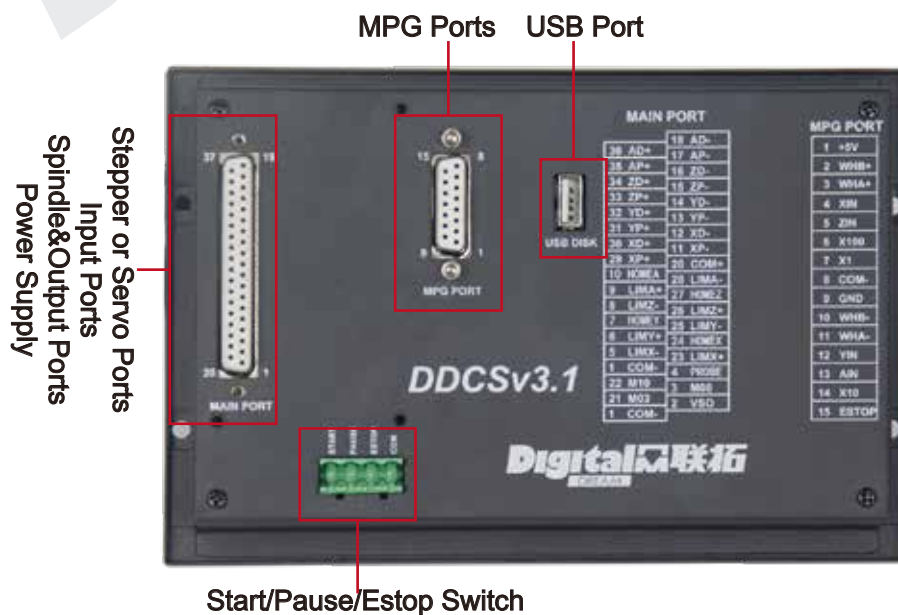


Figure 2-2 Wiring and Ports

As the Figure shows, the wiring section of the controller has Input Ports, Spindle&Output Ports, stepper/Servo control step and direction output, MPG Port, USB Port and Power supply Port.

2.3 START/PAUSE/ESTOP Switch Wiring

As Figure 2-3 shows, the power interface, there is a screw terminal for connection. The marks are the “START”/”PAUSE”/”ESTOP” and “COM” for external switches. And Figure 2-4 is the circuit drawing for the connection. The “Start” and “Pause” can be defined as other functions. Detailed information please refers to #446 and #447 in Param Page.



Figure 2-3 START/PAUSE/ESTOP/COM interface

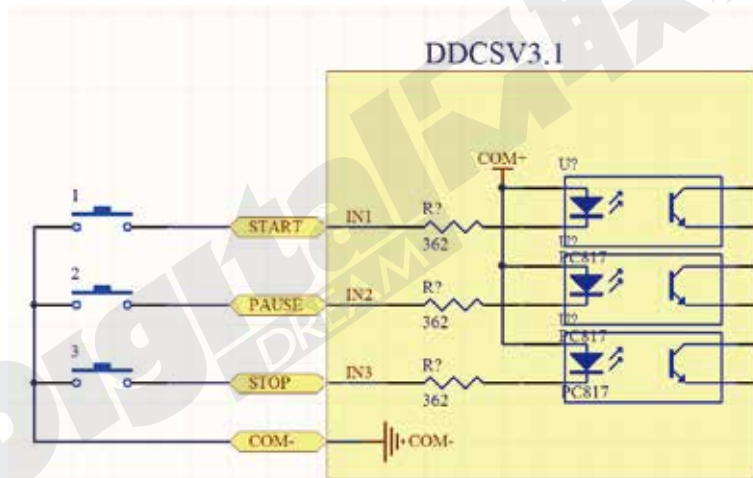


Figure 2-4 Circuit drawing of START/PAUSE/ESTOP/COM

2.4 USB Wiring

This USB port is the standard USB A-type. A 50cm USB extension cord with installation plug is supplied with the controller. See the diagram Figure 2-5 for reference.



Figure 2-5 USB interface

2.5 MPG Port

The MPG port is shown in Figure 2-6. It is the DB15 Female terminals next to the USB port.

The users need to weld the MPG cables into the DB15 Male terminal, and plug-in to the MPG port of the controller MPG port.

NOTE: Only when the IO port's power supply is wired correctly, will the MPG work correctly.

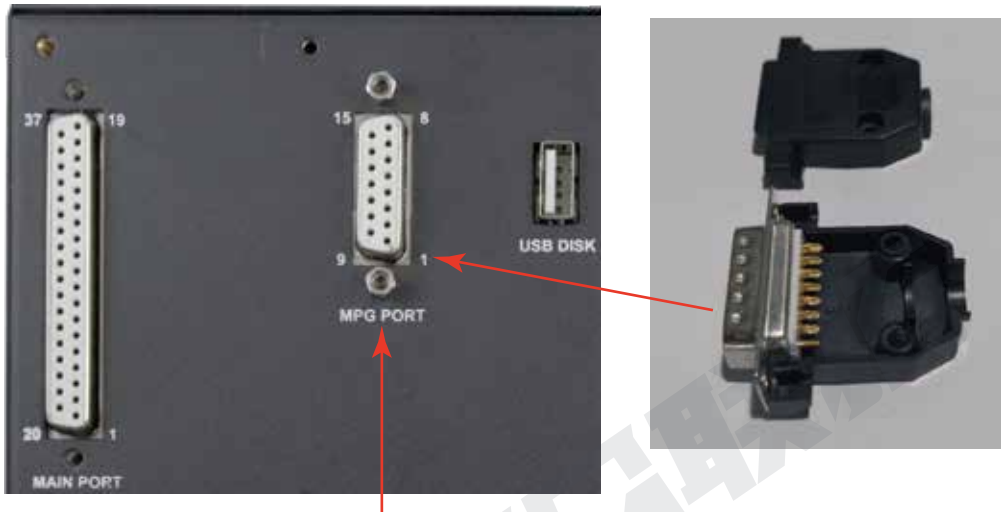


Figure 2-6 MPG port and accessory connector for it

The MPG port has 15 pins, see Table 2-1 for reference. See Table 2-2 and table 2-3 for the wiring.

Pin No.	Pin Mark	Definition	Notes
1	+5V-W	MPG Power Supply 5V Positive	Exclusive Power supply Positive of MPG, which can restore the fuse connection with a 200MA of the system power supply.
2	WHB+	MPG B phase positive	MPG B differential input positive terminal
3	WHA+	MPG A phase positive	MPG A phase differential input positive terminal
4	X-IN	Select switch of X axis	Connect with GND, indicates selecting X axis, open indicates no selecting
5	Z-IN	Select switch of Z axis	Connect with GND, indicates selecting Z axis, open indicates no selecting
6	X100	Select switch 100 X	Connect with GND, indicates selecting 100 X, open indicates no pulse
7	X1	Select switch 1 X	Connect with GND, indicates selecting 1 X, open indicates no pulse
8	COM-	Switch Signal common terminal	the switch signal common terminal, which can restore the fuse connection with a 200MA of the system power supply.
9	GND	MPG Power supply Ground	MPG power supply ground
10	WHB-	MPG B phase negative	MPG B phase differential input negative terminal
11	WHA-	MPG A phase negative	MPG A phase differential input negative terminal
12	Y-IN	Select switch of Y axis	Connect with GND, indicates selecting Y axis, open indicates no selecting
13	A-IN	Select switch of A axis	Connect with GND, indicates selecting A axis, open indicates no selecting
14	X10	Select switch 10 X	Connect with GND, indicates selecting 10 X, open indicates no pulse
15	ESTOP	ESTOP of MPG	Connect with GND, indicate ESTOP is in effect. Open indicates Estop is invalid.

Table 2-1 DDCS's MPG Port



DDCS Wiring Pin	MPG Function	MPG Pin Mark	MPG Output Cable Color
+5V-W	Power Supply +	Vcc(+5V)	Red, Green/Black
WHB+	B Phase +	B+	White
WHA+	A Phase +	A+	Green
X-IN	X Axis	X	Yellow
Z-IN	Z Axis	Z	Brown
X100	X100 Ratio	X100	Orange
X1	X1 Ratio	X1	Grey
COM-	Enable Switch	COM	Black/Orange,Blue/Yellow
GND	Power Supply -	GND	Black, White/Black
WHB-	B Phase -	B-	Purple/Black
WHA-	A Phase -	A-	Purple
Y-IN	Y Axis	Y	Black/Yellow
A-IN	A Axis	A	Black/Brown
X10	X10 Ratio	X10	Black/Grey
ESTOP	ESTOP	ESTOP	Blue

Table 2-2 DDCS Wiring with standard MPG

Note: If you want to use the single-terminal MPG (there is no A-B-MPG), please refer to table 2-3 for reference. As for the unlisted MPG, please take the differential MPG wiring mode.

DDCS Wiring Pin Mark	MPG Pin Mark and Color	
WHA+	A+	Green
WHA-	0V	Black
WHB+	B+	White
WHB-	0V	Black

Table 2-3 DDCS Wiring with Single-terminal MPG

2.6 Main Port Wiring

Figure 2-7 shows the main port position:

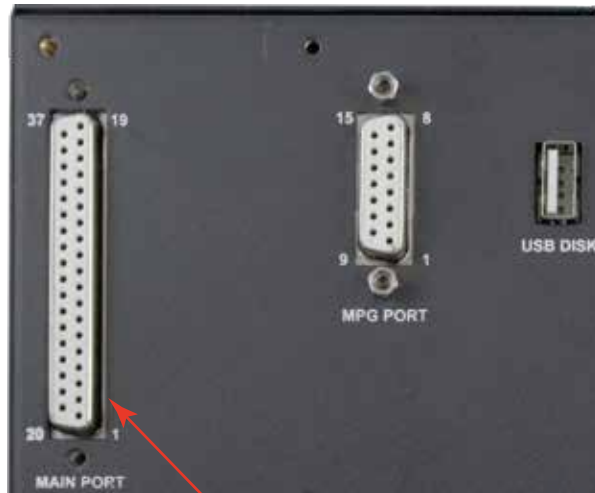


Figure 2-7 Main Port

We supply a wiring terminal to fit the 37 pin female connector of the main port. This simplifies the wiring. Please note in Figure 2.8, at the 4 corners, there are screws to lock the terminal to the controller.



Figure 2-8 Main Port with wiring terminal

There are 3 rows of connectors on the terminal block. Please see Pic 2-9 which shows the pin allocation to each row. It supports the following interfaces:

- 1) Stepper/Servo Output Ports;
- 2) The Spindle Control Output Ports;
- 3) The E-stop, Limit, Home and Probe and other Inputs ports;
- 4) 24V DC Power Supply ports for the Controller;
- 5) 24V DC Power Supply ports for the I/O Unit.

For the connector to pin mapping please refer to Table 2-4:

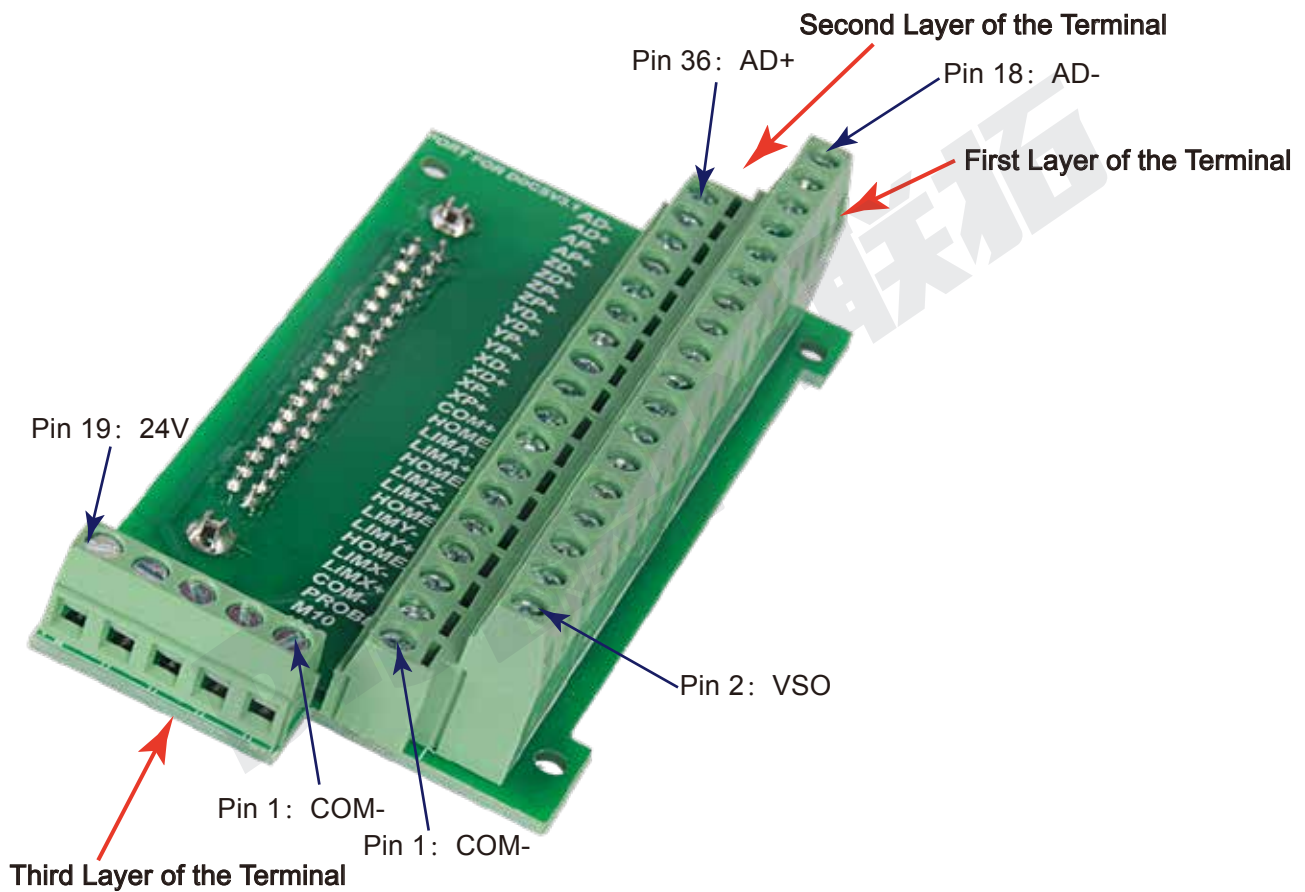


Figure 2-9 3-Layers wiring terminal

First Layer of the Terminal																	
PIN 18	PIN 17	PIN 16	PIN 15	PIN 14	PIN 13	PIN 12	PIN 11	PIN 20	PIN 28	PIN 27	PIN 26	PIN 25	PIN 24	PIN 23	PIN 4	PIN 3	PIN 2
AD-	AP-	ZD-	ZP-	YD-	YP-	XD-	XP-	COM+	AL--	ZHOME	ZL++	YL--	XHOME	XL++	PROBE	M8	VSO
Second Layer of the Terminal																	
PIN 36	PIN 35	PIN 34	PIN 33	PIN 32	PIN 31	PIN 30	PIN 29	PIN 10	PIN 9	PIN 8	PIN 7	PIN 6	PIN 5	PIN 1	PIN 22	PIN 21	PIN 1
AD+	AP+	ZD+	ZP+	YD+	YP+	XD+	XP+	AHOME	AL++	ZL--	YHOME	YL++	XL--	COM-	M10	M3	COM-
Third Layer of the Terminal																	
PIN 19	PIN 37	PIN 20	PIN 1	PIN 1													
24V	GND	COM+	COM-	COM-													

The Pin No. is DB37 interface Pin No.

Table 2-4 Main Port Pin No. and Mark

First Layer of the Terminal		
Pin No.	Pin Mark	Definition
PIN 18	AD-	Direction Signal Negative Output of A Axis (5V)
PIN 17	AP-	Pulse Signal Negative Output of A Axis (5V)
PIN 16	ZD-	Direction Signal Negative Output of Z Axis (5V)
PIN 15	ZP-	Pulse Signal Negative Output of Z Axis (5V)
PIN 14	YD-	Direction Signal Negative Output of Y Axis (5V)
PIN 13	YP-	Pulse Signal Negative Output of Y Axis (5V)
PIN 12	XD-	Direction Signal Negative Output of X Axis (5V)
PIN 11	XP-	Pulse Signal Negative Output of X Axis (5V)
PIN 20	COM+	All between "COM+"s are conducting.All between "COM-"s are conducting. Between COM+ and COM- there is 24VDC power.COM+ is Positive side.
PIN 28	AL--	Limited Signal Input at A-- direction
PIN 27	ZHOME	Home Signal Input of Z Axis
PIN 26	ZL++	Limited Signal Input at Z++ direction
PIN 25	YL--	Limited Signal Input at Y-- direction
PIN 24	XHOME	Home Signal Input of X Axis
PIN 23	XL++	Limited Signal Input at X++ direction
PIN 4	PROBE	Probe Signal Input
PIN 3	M8	Start Cooling Signal Output for Spindle
PIN 2	VSO	Speed output (0-10V) VSO Signal Output
Second Layer of the Terminal		
Pin No.	Pin Mark	Definition
PIN 36	AD+	Direction Signal Positive Output of A Axis (5V)
PIN 35	AP+	Pulse Signal Positive Output of A Axis (5V)
PIN 34	ZD+	Direction Signal Positive Output of Z Axis (5V)
PIN 33	ZP+	Pulse Signal Positive Output of Z Axis (5V)
PIN 32	YD+	Direction Signal Positive Output of Y Axis (5V)
PIN 31	YP+	Pulse Signal Positive Output of Y Axis (5V)
PIN 30	XD+	Direction Signal Positive Output of X Axis (5V)
PIN 29	XP+	Pulse Signal Positive Output of X Axis (5V)
PIN 10	AHOME	Home Signal Input of A Axis
PIN 9	AL++	Limited Signal Input at Z-- direction
PIN 8	ZL--	Limited Signal Input at A++ direction
PIN 7	YHOME	Home Signal Input of Y Axis
PIN 6	YL++	Limited Signal Input at Y++ direction
PIN 5	XL--	Limited Signal Input at X-- direction
PIN 1	COM-	All between "COM+"s are conducting.All between "COM-"s are conducting. Between COM+ and COM- there is 24VDC power.COM- is Negative side.
PIN 22	M10	Start Lubrication Signal Output for Spindle
PIN 21	M3	Start Spindle Signal Output
PIN 1	COM-	All between "COM+"s are conducting.All between "COM-"s are conducting. Between COM+ and COM- there is 24VDC power.COM- is Negative side.
Third Layer of the Terminal		
Pin No.	Pin Mark	Definition
PIN 19	24V	Positive Side of Power Supply for Controller system
PIN 37	GND	Negative side of Power Supply for controller system
PIN 20	COM+	Positive Side of Power Supply for IO Port
PIN 1	COM-	Negative side of Power Supply for IO Port
PIN 1	COM-	All between "COM+"s are conducting.All between "COM-"s are conducting. Between COM+ and COM- there is 24VDC power.COM- is Negative side.

Table 2-5 Main Port Pin No. and definition

2.6.1 Spindle control output

PIN3(M8),PIN22(M10),PIN2(VSO) and PIN21(M3) is for spindle control output.The spindle control output terminal offers connections for Start and Stop of the Spindle (M3/M5), Start/Stop of Cooling (M8/M9) and Start/Stop of Lubrication (M10/M11). These three output terminals are signals open to ground. The highest electric current can be absorbed is 50mA. The speed controlling output terminal can output 0-10V. It can adjust the speed of the spindle motor by sending the voltage between 0 and 10V to the VFD according the the Spindle Speed Setting.

Controlling the speed of a spindle with a VFD (variable frequency drive) only needs the Start/Stop signal and the 0-10V signal to control the frequency.

The following table 2-6 shows the wiring with Sunfar VFD:

	
DDCS V3.1 Wiring pin	SUNFAR E300
Speed output (0-10V) PIN2(VSO)	AI
Start and stop of spindle PIN21(M3)	FWD
Output ground	CM

Table 2-6 **DDCS** and VFD wiring

PIN3(M8),PIN22(M10) and PIN21(M3) is also can be used for OUTPUT ports.For example,it can be used for a Relay output port.For example the Figure 2-10 shows the wiring methods:

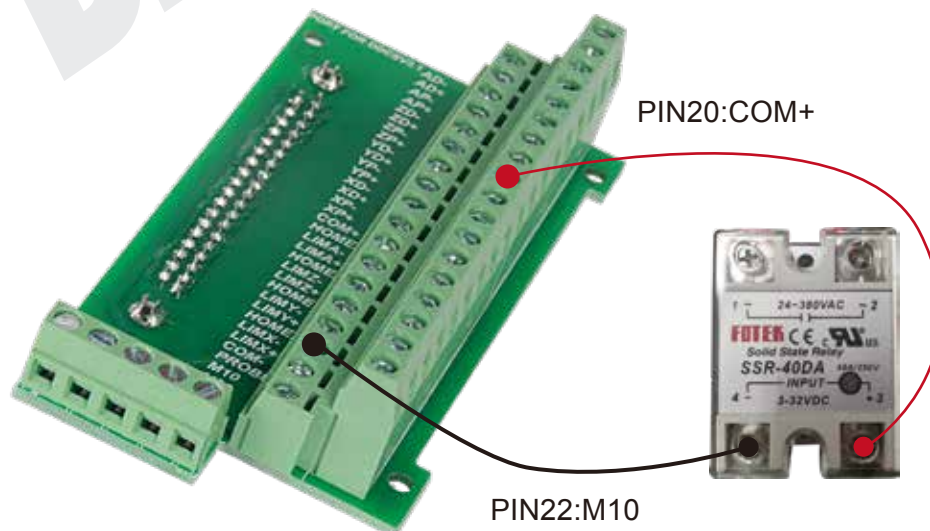


Figure 2-10 Wiring Methods with Relay

2.6.2 Limit, Home and Probe Inputs, and the Power for the Input

PIN6(YL++), PIN23(XL++), PIN25(YL--), PIN5(XL--), PIN28(AL--), PIN9(AL++), PIN8(ZL--), PIN26(ZL++) are the Limit ports.

PIN10(AHOME), PIN27(ZHOME), PIN7(YHOME), PIN24(XHOME) are the Home Ports.

PIN4(PROBE) is the Probe Port.

The following wiring Figures and circuit Figures will show the connection of the Limit, Home and Probe Wiring.

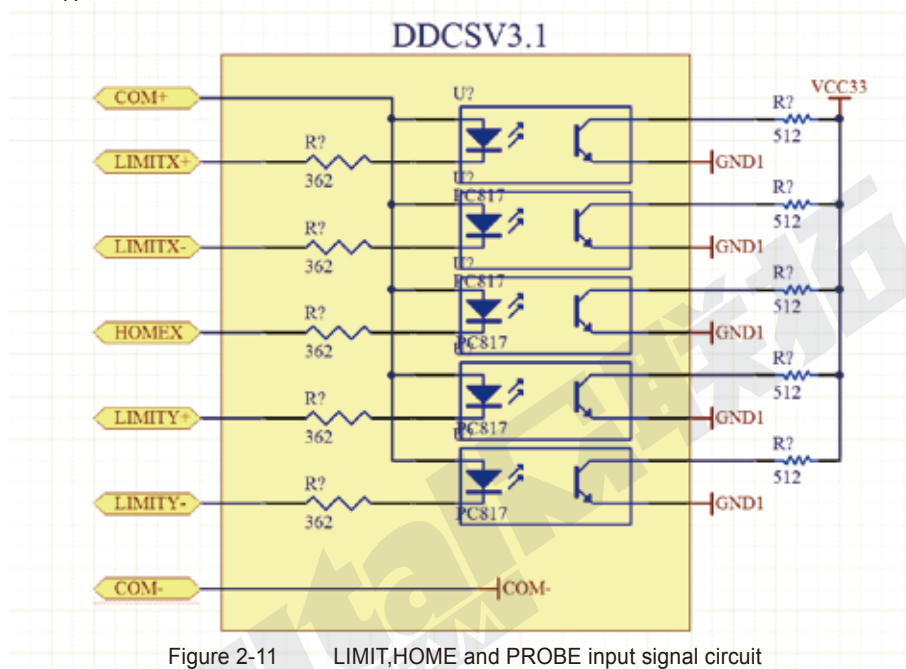


Figure 2-11 LIMIT, HOME and PROBE input signal circuit

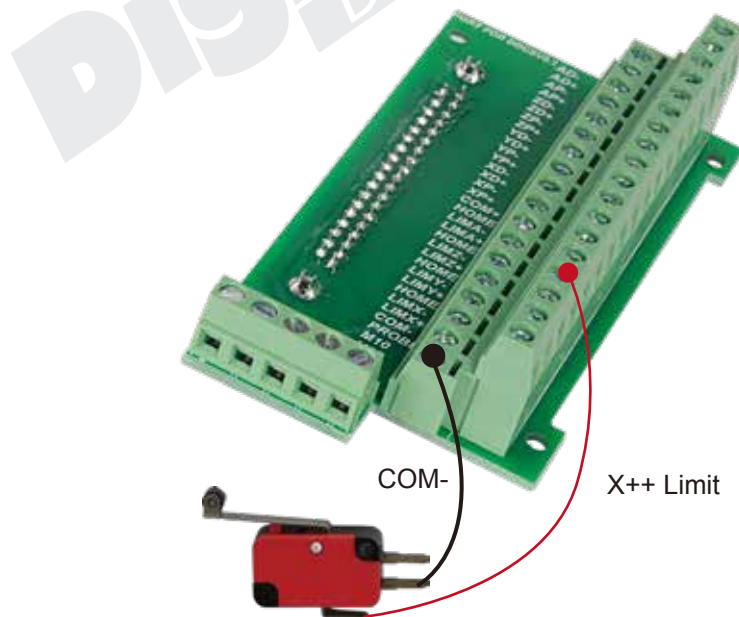


Figure 2-12 The Limit wiring at X++ direction with mechanical limited switch

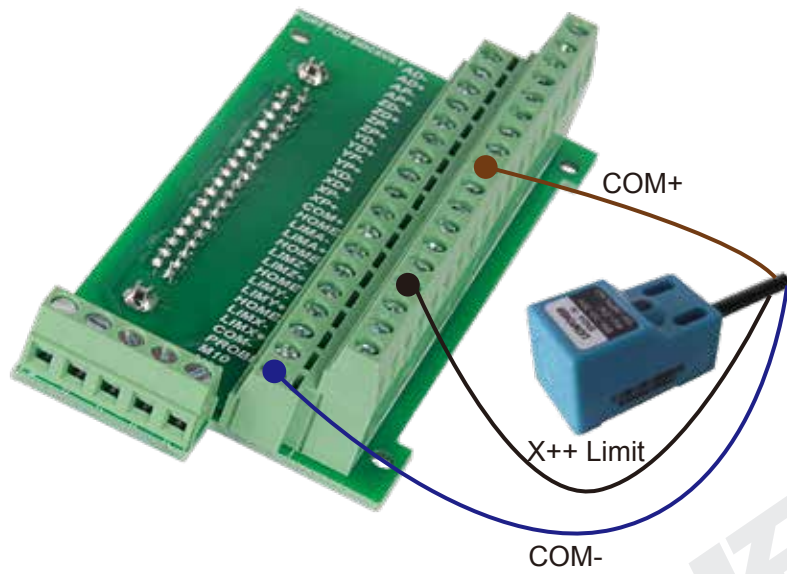


Figure 2-13 The Limit wiring at X++ direction with 3-line proximity switch

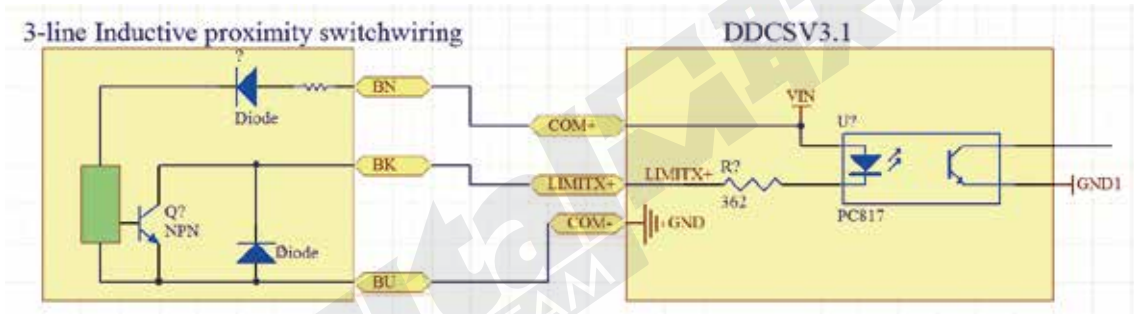


Figure 2-14 The circuit of 3-line Inductive proximity switch

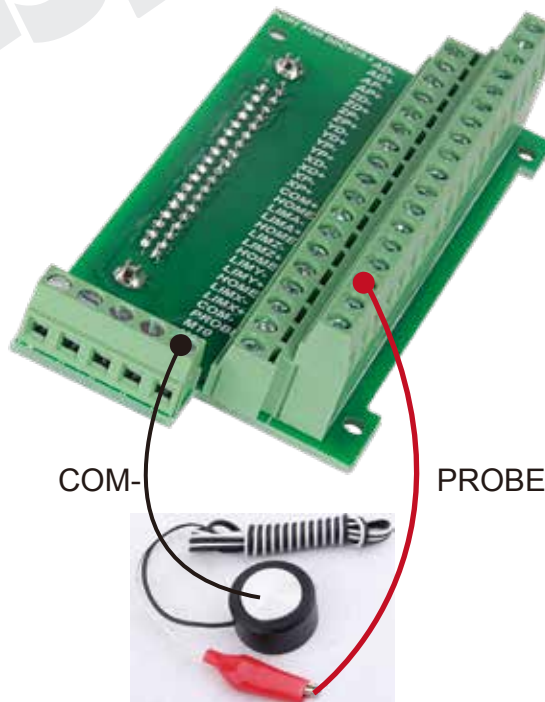


Figure 2-15 The Probe Wiring

2.6.3 Stepper/Servo Control Output

The stepper/servo control output, we cite differential Pulse and Direction output method, Max. 500Khz per axis. DDCS V3.1 there is 3 or 4 axis for option

PIN 18 (AD-), PIN 36 (AD+), PIN 17 (AP-), PIN 35 (AP+) is A Axis Control Output Pins;

AD- means the Direction signal negative output for A axis, AP+ means the Direction signal positive output for A axis, AP- means the Pulse signal negative output, AP+ means the Pulse Signal positive output.

The Pulse and Direction signal output voltage is $\pm 5V$.

PIN 18(AD-), PIN 36 (AD+), PIN 17 (AP-), PIN 35 (AP+) is A Axis Control Output Pins;

PIN 16 (ZD-), PIN 34 (ZD+), PIN 15 (ZP-), PIN 33 (ZP+) is Z Axis Control Output Pins;

PIN 14 (YD-), PIN 32 (YD+), PIN 13 (YP-), PIN 31 (YP+) is Y Axis Control Output Pins;

PIN 12 (XD-), PIN 30 (XD+), PIN 11 (XP-), PIN 29 (XP+) is X Axis Control Output Pins.

The following Figure 2-16 is the example of stepper driver wiring as A axis.

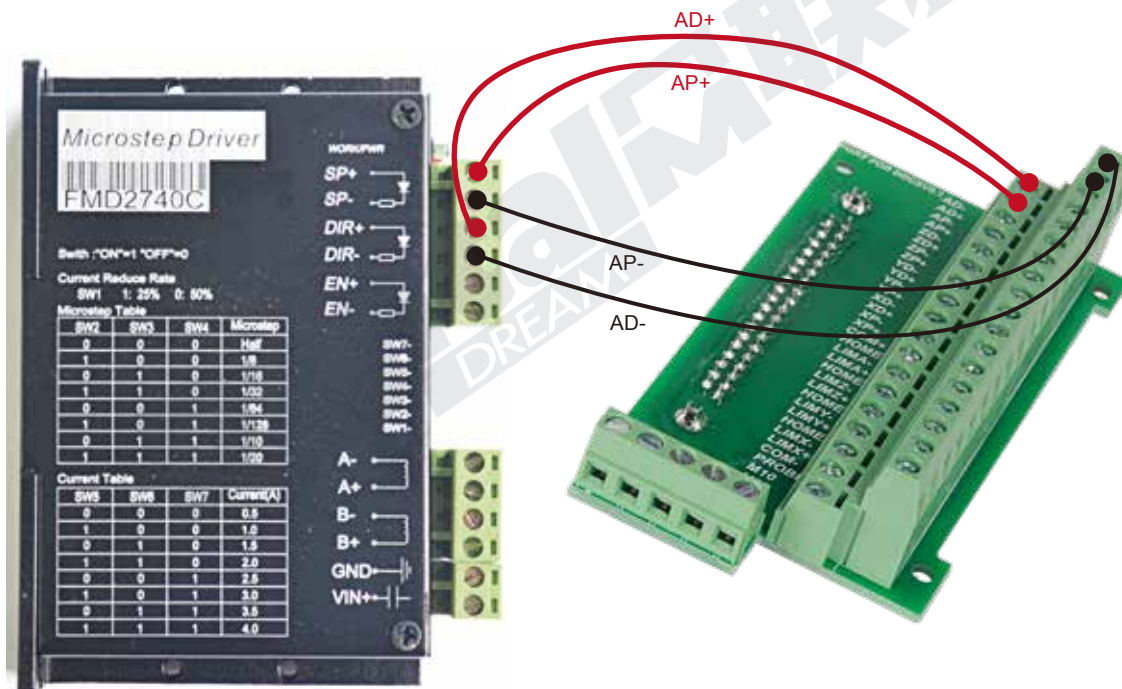


Figure 2-16 The Stepper driver wiring as A Axis

2.6.4 Power Supply Input

DDCS V3.1 needs two power supplies, Main power is for system, IO Port is for Input and Output ports. Both power supply is 24VDC, current is not less than 1A. In the Main port interface, the marked 24V and GND is the main power input ports; the COM+ and COM- is the IO power input ports. Please keep in mind, only when the two power supplies are connected correctly the controller can be work properly.

Because of the IO power, the controller system can supply power to all the IO ports, the IO ports is no need of the external power any more, for example, the relay.

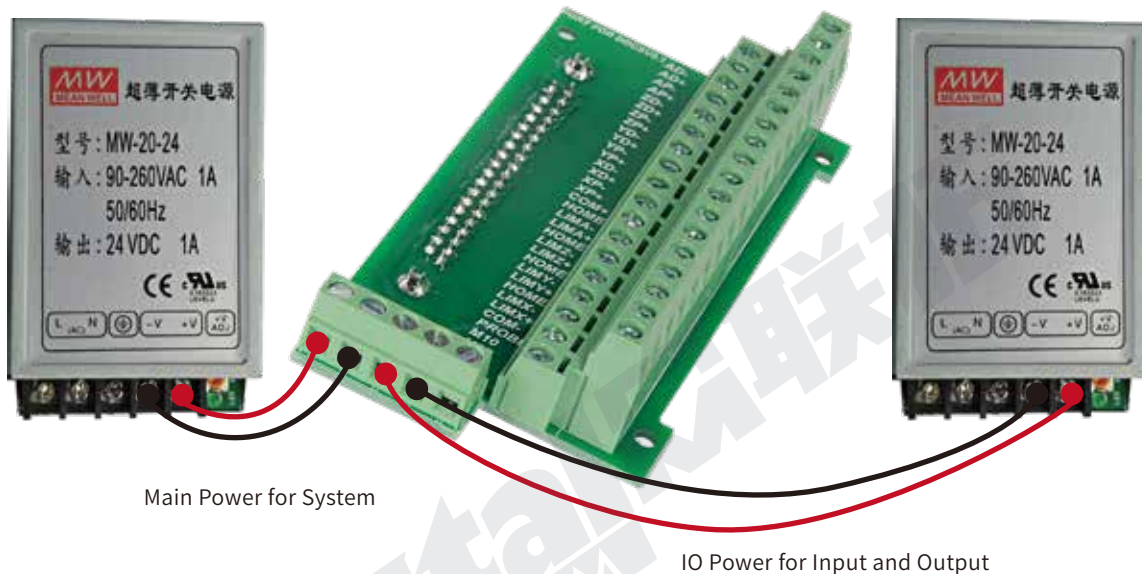


Figure 2-17 Power Supply for Controller System and IO port

In order to avoid electrical noise it is highly recommended to use two separate 24V power supplies.

Note also that the stepper motors/servo motors should be powered from a separate higher capacity power supply as these really are a source of electrical noise.

3 Software and Operation

3.1 Interface description

The software interface contains 3 pages. Main page, File page and Configuration page.

3.1.1 Main page

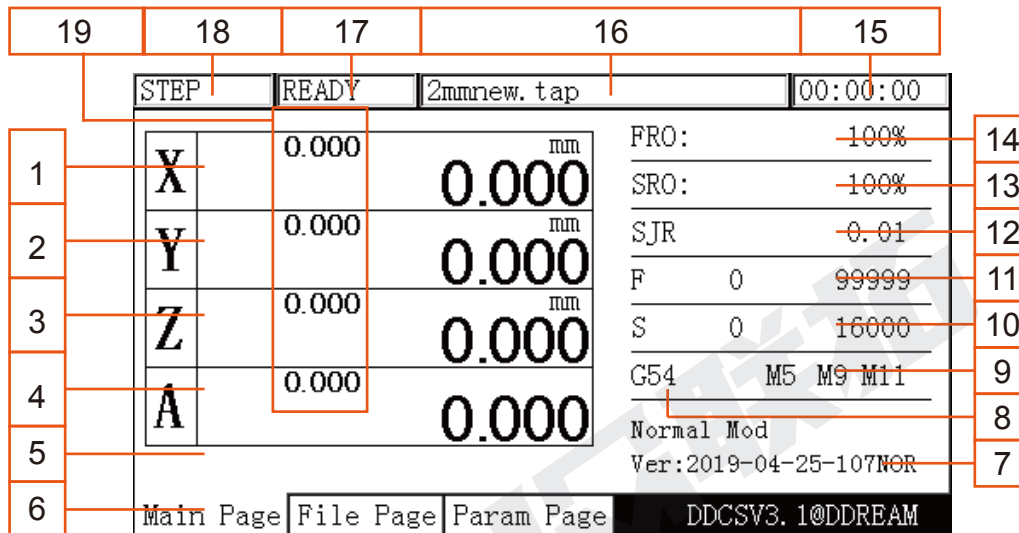


Figure 3-1 Metric Units In Main Page

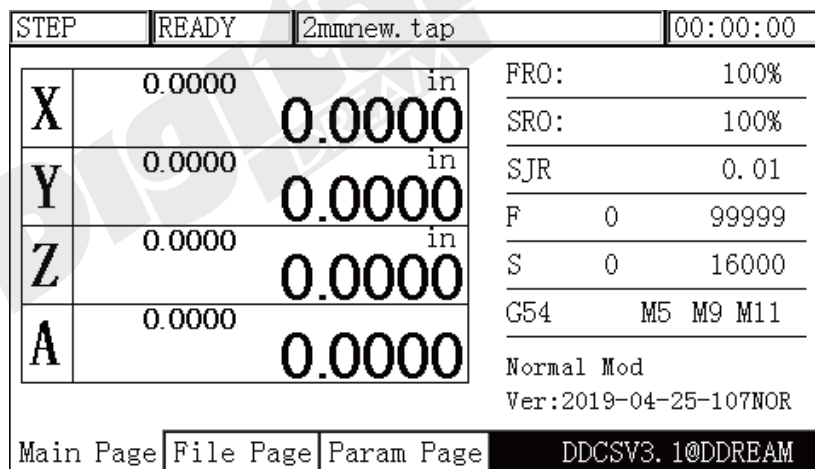


Figure 3-2 Imperial Units In Main Page

The Figure 3-1 shows the Main page of the DDCS. It is divided into status column, coordinate display column, basic parameter column, and notification column. In total, it is divided into 19 sections in detail. Here the detailed description of the 19 sections :

1.X Coordinate

This column shows the current coordinate value of X. The display range is -99999.999~+99999.999 in mm;

2.Y Coordinate

This column shows the current coordinate value of Y. The display range is -99999.999~+99999.999 in mm;

3、Z Coordinate

This column shows the current coordinate value of Z. The display range is -99999.999~+99999.999 in mm;

4、A Coordinate (This section has no definition in the 3-axis)

This column shows the current coordinate value of A. The display range is -99999.999~+99999.999 in mm;

5、Current Operation

When the controller runs the G code file, it will show the current operation line number and coordinates. When the operation state is READY, it will show nothing

6、Page

The page shows the current page. This controller has 3 pages, Main Page, File Page and Configuration Page. Press Page button to move between the Pages.

7、Operation Window

This message window switches between 3 displays. It shows the prompt message of several keys and the 2nd (second function)

The message displayed while in normal state is: Normal Mode.

The message displayed of the 2nd function status is:

X-: goto 0, Y-: zero, Z-: home, A-: probe, Pause: goto break

If you now click X-, the machine will move to Zero. If you click A-, the probe function will be activated. If you click Y-, all coordinates will be set to Zero. If you click Z-, the machine will home. If you click Start, the Start Line window appears and you can enter the G-code line you want to start from. Click on Pause to enter the breakpoint CONT Callback Function.

Tip:

You need to click these functions twice to activate them (first click is “select”, second click is “activate”).

Tip:

When you are in an Editing Window, you can insert values by using the following keys:

X-: moves the cursor left

X+: moves the cursor right

Y-: decrease the value

Y+: increases the value

Z-: Enter

Z+: Cancel

8 Coordinate System

With the control panel it is very easy to control your Machine Coordinates and Work Offset Coordinates. Click FRO/SRO/SJR (from now on only called FRO) 6 times until the coordinate system is highlighted. Here you can display G54 to G59 and MACH (Machine Coordinates) by clicking A+ and A-

Tip

After selecting a function with the FRO key you use the A+ button to Select and the A- button to Modify the value.

If the function can be edited, the Editing Window will open and you can edit with:

X-: moves the cursor left

X+: moves the cursor right

Y-: decrease the value

Y+: increases the value

Z-: Enter

Z+: Cancel

9、Status of M3/M5,M8/M9 or M10/M11

M3/M5: Start/Stop Spindle

M8/M9 : Start/Stop of Cooling

M10/M11: Start/Stop of Lubrication

10、Speed of spindle

S stands for Spindle Speed. Click FRO till S is highlighted,click A- to modify and edit the value you want.

The display shows two values. The left value is the real time Spindle Speed, the right value shows the default Spindle Speed. The Default Spindle Speed can be changed, use the A- key to modify.

11、Feed speed

F stands for Feed Speed. Click FRO till F is highlighted, click A- to modify and edit the value you want.

The display shows two values. The left value is the real time Feed Speed, the right value shows the default Feed Speed. The Default Feed Speed can be changed, use the A- key to modify and edit.

12、SJR

SJR controls the jogging of the machine. Click FRO till SJR is highlighted.

First Option: MODE

Check window 18 and you can see what Jog Mode you are in. By clicking MODE you can change Jogging to Continuous, Step or to MPG, Window 18 will display this function.

When in Cont Mode, A+ and A- can adjust the speed in 10% increments

When in Step Mode, A+ and A- can change between the 4 distances set by #2020,#2021,#2022,#2023.

When in MPG mode you can use the MPG to jog the machine

Second Option: Jog a defined distance

13、SRO

SRO controls the Spindle Speed. Click FRO till SRO is highlighted, use A+ and A_ to adjust the Spindle Speed in 10% increments

14、FRO

FRO controls the Feed Speed. Click FRO till FRO is highlighted. Use A+ and A- to adjust the Feed Speed in 10% increments

15、Working time

This column shows the processing time of the G code operation. Time keeping is halted during Pause

16、Processing file

This column shows the name of the processing files. In the formal situation, it only shows the filename. Under the situation of CONT adjust, it will also show the content of the file.

17、Operating Status

This column shows the operating state. The status and implications can be displayed as follows:

Busy: Operation is running

Reset: Reset flashing = controller not active. To activate the controller click Reset

READY: Ready state. Controller is ready and all operations can be performed

18、Feed status

This window shows the feed status of Jogging and File Processing.

AUTO: displayed while processing and executing the G code file

CONT: indicates Jog CONTINUOUS. You can Jog manually with the “-” or “+” keys of X Y Z and A. A short click will move the axis in the defined step, a long click will move the axis till you let go

Step: Jogging in Step Mode

MPG: MPG mode. MPG takes over Jog control

2nd: 2nd mode. In 2nd mode you can choose all functions displayed in window 7

19、Mach Coordinate

This Window shows the Machine coordinate values.

3.1.2 File Management Page

Click the Page button once and the File Management Page will open

STEP	READY	2mmnew.tap	00:00:00
Name	Size	Time	
..	[DIR]	1970/01/09 08:18	
install	[DIR]	1970/01/09 08:18	
file	[DIR]	1970/01/09 08:18	
2mmnew.tap	1525365	2018/07/15 17:12	
BMP7.bmp	261174	1980/01/01 00:00	
target file.textClipping	207	2019/05/09 15:37	
BMP8.bmp	261174	1980/01/01 00:00	
setting	170000	1980/01/01 00:00	
BMP9.bmp	261174	1980/01/01 00:00	
BMP0.bmp	261174	1970/01/01 00:00	
Bear Shape 3d v2.crv3d	5411840	2016/01/18 16:35	
3D Roughing Bear v2.tap	553829	2016/01/18 16:34	
F1-COPY F2-PASTE F3-EDIT F4-NAME INS-NEW DEL-DEL			
Main Page File Page Param Page			DDCSV3.1@DDREAM

Figure 3-3 File Page

As the Figure 3-3 shows, the file management page can be divided into 5 columns

1、Change Directory

“...” shows to the “Return to previous menu”

2、File list of current Directory

Shows the folders and files in current folder

3、Files size column shows file size in byte

4、Modification time and date

5、Keyboard Operation Keys

In 3.1 Version,we added keyboard operation methods,in the file page,the users also can use the keys on keyboard to operate.

Note:For the file selection,you can also use the MPG and USB Keyboard to turns and find out if the file list is too long.

3.1.3 Parameter Page

Click the Page button once and the File Management Page will open:

STEP	READY	2mmnew.tap	00:00:00
No.	Param Name	Value	Unit
[Top parameters]			
5	minimum log radius of 4axis machini	5.000	mm
6	A axis rotate reference axis	not rotate	
104	A axis optimal path when G0 run	No	
[Motor parameters]			
33	Motor start speed	50.000	mm/min
34	X axis pulse equivalency	2560.000	pulse/mm
34	Y axis pulse equi2alency	2560.000	puls4/mm
36	Z axis pulse equivalency	2560.000	pulse/mm
38	A axis pulse equivalency	640.000	
39	A axis pulse unit	pulse/deg	
40	AB axis Selection	A axis	
390	X axis DIR signal Electric Level	Low	

Main Page | File Page | Param Page | DDCSV3.1@DDREAM

Figure 3-4 Parameter Page

As the Figure 3-4 shows, the configuration page can be divided into 4 columns:

1. Parameter Number

Each parameter has a specific number, the parameter can be modified .

2. Parameter Name

The definition of the Parameter is listed in the Parameter Name column. All Parameters are divided into groups according to their function.

3. Parameter Value

The Parameter Value column lists the value of each Parameter. This value can be configured

4. Parameter Unit

The Parameter Unit lists the unit of each parameter.

Note:For the Parameter selection,you can use the USB keyboard and MPG to find the files quickly.

3.2 Definition of Keys

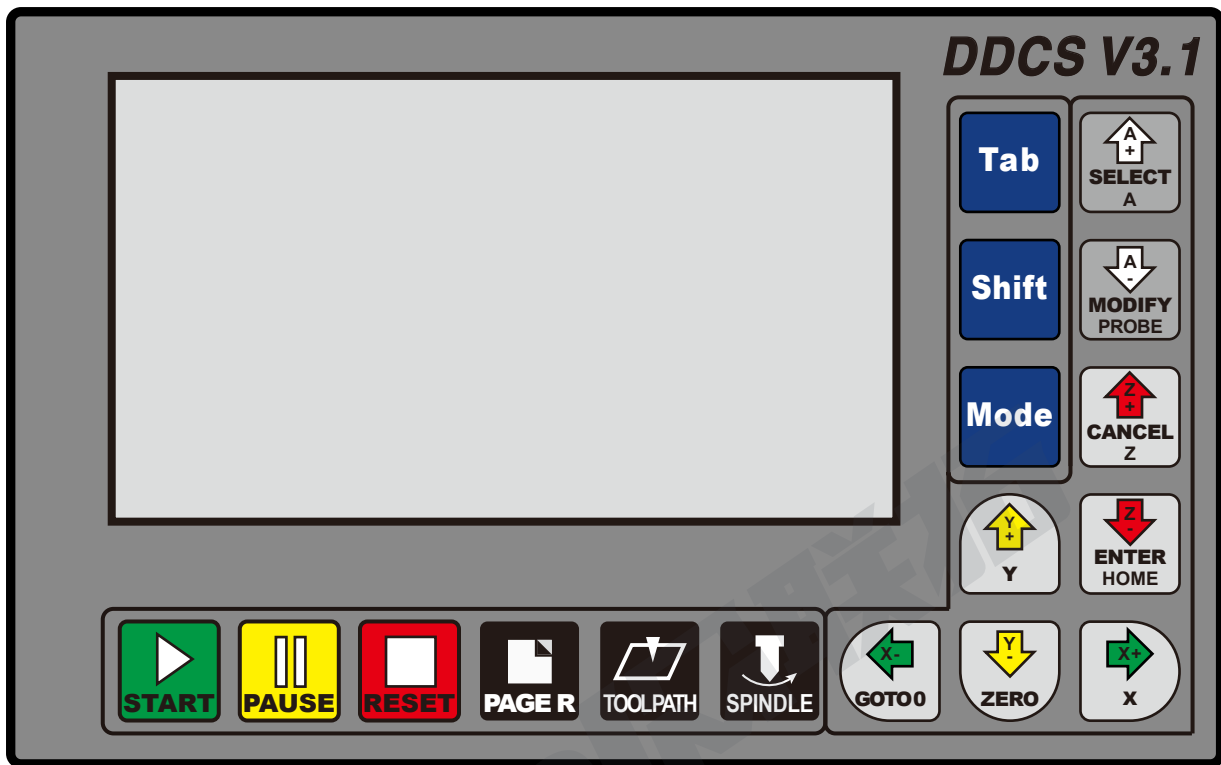


Figure 3-5 Keys Layout

The Figure 3-5 shows the key layout of the DDACS. The Controller DDACS has 17 keys. Please see table 3-1 for reference.

Keys Icon	Function No.	Definition	Notes
	1	Start operation	After loading the G code file, please press this key to start the operation. In case of Pause Status, press this key to continue the processing operation.
	1	Pause operation	Press this key to Pause the operation.
	1	Reset and E-STOP	If Reset is blinking, press this key to activate the controller. Press this key to stop processing urgently.
	1	Page switch	Switch through File Management Page, Processing Main Page and Parameter Configuration Page.
	1	Toolpath display switch	Switch the display between Coordinate Display or Tool Path Tracking display.
	1	Spindle manual start/close	Press this key to manually switch the spindle on or off. Can not be used if Reset is blinking and while processing an operation (Busy)
















Keys Icon	Function No.	Definition	Notes
	3	1: X axis moves left; 2: Cursor moves left 3: Goto Zero function	In "CONT Mode", the X axis will continuously move negative after pressing this key. In "STEP Mode" X will move negative in steps. When in "Line Editing" or default F/S value modification, this key moves the cursor left. When in "2nd Function", this key has the goto Zero function.
	3	1: X axis moves right; 2: Cursor moves right 3: X axis select	In "CONT Mode", the X axis will continuously move positive after pressing this key. In "STEP Mode" X will move positive in steps. When in "Line Editing" or default F/S value modification, this key moves the cursor right. When in "home/zero-clearing/ gotoz", this key opens the X axis coordinate edit window.
	3	1: Y axis moves forward; 2: Parameter value increases 3: Y axis select	In "CONT Mode", the Y axis will continuously move positive after pressing this key. In "STEP Mode" Y will move positive in steps. When in "Line Editing" or default F/S value modification, this key increases the value. When in "home/zero-clearing/ gotoz", this key this key opens the Y axis coordinate edit window.
	3	1: Y axis move backward; 2: Parameter value decreases; 3: Start the current coordinate 0-clearing	In "CONT Mode", the Y axis will continuously move negative after pressing this key. In "STEP Mode" Y will move negative in steps. When in "Line Editing" or default F/S value modification, this key decreases the value. When you start the 2nd function, this key has the Ycoordinate function.
	3	1: Z axis Plummer block 2: Z axis select 3: cancel	In "CONT Mode", the Z axis will continuously move positive after pressing this key. In "STEP Mode" Z will move positive in steps. When in "home/zero-clearing/ gotoz", this key opens Z axis coordinate edit window. This key is also CANCEL key.
	3	1: Z axis down 2: home 3: enter/select	In "CONT Mode", the Z axis will continuously move negative after pressing this key. In "STEP Mode" Z will move negative in steps. This key serves as the ENTER key and also is the HOME key
	4	1: A axis rotates in forward direction 2: A axis select 3: parameter increases 4: F/S default select/cancel	In "CONT Mode", the A axis will continuously move positive after pressing this key. In "STEP Mode" A will move positive in steps. When in "home/zero-clearing/ gotoz", this key opens the A axis coordinate edit window. When in FRO/ SRO/ SJR this key increases the parameter value. When in F or S, this key switches between default value or G code value
	4	1: A axis rotates in inversion direction 2: Probefunction 3: Parameter decreases 4: F/S default modification	In "CONT Mode", the A axis will continuously move negative after pressing this key. In "STEP Mode" A will move negative in steps. When in 2nd function, this key activates the PROBE. When in FRO/ SRO/ SJR this key decreases the parameter value. When in F or S, this key will open the Editing Window
	2	1: FRO/SRO/SJR/F/S/G; 2: file copy	This switch will highlight the processing parameters FRO/ SRO/SJR/F/S/G54-59-MACH/M3-M11 While in BUSY it can activate FRO and SRO In File Management this is the COPY key
	2	1: Second function start 2: file paste	This key will shift to the second Mode (goto, zero, home, probe, goto breakpoint) . In File Management it is the PASTE key
	2	1: mod switch 2: file delete	When in READY, this key changes the Jog mode from Continuous to Step and MPG control. In File Management it is the DELETE key

Table 3-1 List of Keys' function

3.3 Operation of common functions

TIP

Do not press two keys at the same time

For example:  +  indicates that you should first press  and then release this key, then press 

3.3.1 File Management

When in the Main Page press  to enter the File Page, See Figure 3-6 :

STEP	READY	2mmnew. tap	00:00:00
Name	Size	Time	
..	[DIR]	1970/01/09 08:18	
file	[DIR]	1970/01/09 08:18	
install	[DIR]	1970/01/09 08:18	
BMP10. bmp	261174	1970/01/01 00:41	
2mmnew. tap	1525365	2018/07/15 17:12	


F1-COPY | F2-PASTE | F3-EDIT | F4-NAME | INS-NEW | DEL-DEL
Main Page | File Page | Param Page | DDCSV3.1@DDREAM


Figure 3-6 File management page

The displays will show all folders and files in the root directory. The Name of folders and files, the size of files and the time and date of manipulation. The blue strip indicates the current valid target location.

Press  to move up

Press  to move down

Press  to quit the file management page

Press  If the blue bar is at “..”, the Enter button will change to the last directory. If the

blue bar highlights a folder, it will open the folder. If the blue bar highlights a G code file, this button will load the G code and go back to the Main Page for processing. If the blue bar highlights a .set file, it will upgrade the system. In this case make sure you delete the settings file or the upgrade will overwrite the original settings file too and you will lose your settings.

1) Copy the file

STEP	READY	2mmnew.tap	00:00:00
Name	Size	Time	
..	[DIR]	1970/01/09 08:18	
file	[DIR]	1970/01/09 08:18	
install	[DIR]	1970/01/09 08:18	
2mmnew.tap	1525365	2018/07/15 17:12	

F1-COPY | F2-PASTE | F3-EDIT | F4-NAME | INS-NEW | DEL-DEL
Main Page | File Page | Param Page | DDCSV3.1@DDREAM

Figure 3-7 Select 2mmnew.tap file and copy the file

Here the 2mmnew.tap file is selected. Press the **Tab** key to copy the 2mmnew.tap file

2) Paste the file

STEP	READY	2mmnew.tap	00:00:00
Name	Size	Time	
..	[DIR]	1970/01/09 08:18	
file	[DIR]	1970/01/09 08:18	
install	[DIR]	1970/01/09 08:18	
BMP10.bmp	261174	1970/01/01 00:41	
2mmnew.tap	1525365	2018/07/15 17:12	

F1-COPY | F2-PASTE | F3-EDIT | F4-NAME | INS-NEW | DEL-DEL
Main Page | File Page | Param Page | DDCSV3.1@DDREAM

Figure 3-8 Find the target file where you want to copy to

Choose your target directory or target folder, click **Shift** to paste the 2mmnew.tap file to this directory. See Figure 3-9 for reference

STEP	READY	2mmnew.tap	00:00:00
Name	Size	Time	
..	[DIR]	1970/01/09 08:18	
2mmnew.tap	1525365	1970/01/01 00:42	

F1-COPY | F2-PASTE | F3-EDIT | F4-NAME | INS-NEW | DEL-DEL
Main Page | File Page | Param Page | DDCSV3.1@DDREAM

Figure 3-9 Paste the 2mmnew.tap file to this directory

3) Delete a file

Highlight the required file and click  to delete the file

STEP	READY	2mmnew.tap	00:00:00
Name	Size	Time	
..	[DIR]	1970/01/09 08:18	
file	[DIR]	1970/01/09 08:18	
install	[DIR]	1970/01/09 08:18	
new-1.nc	0	1970/01/01 00:46	
BMP10.bmp	261174	1980/01/01 00:00	
BMP11.bmp	261174	1980/01/01 00:00	
BMP12.bmp	261174	1980/01/01 00:00	
2mmnew.tap	1525365	2018/07/15 17:12	

F1-COPY | F2-PASTE | F3-EDIT | F4-NAME | INS-NEW | DEL-DEL
Main Page | File Page | Param Page | DDCSV3.1@DDREAM

Figure 3-10 Move the blue strip to the 2mmnew.tap file, click MODE to delete

STEP	READY	2mmnew.tap	00:00:00
Name	Size	Time	
..	[DIR]	1970/01/09 08:18	
file	[DIR]	1970/01/09 08:18	
install	[DIR]	1970/01/09 08:18	
new-1.nc	0	1970/01/01 00:46	
BMP10.bmp	261174	1980/01/01 00:00	
BMP11.bmp	261174	1980/01/01 00:00	
BMP12.bmp	261174	1980/01/01 00:00	
BMP13.bmp	261174	1970/01/01 00:46	

F1-COPY | F2-PASTE | F3-EDIT | F4-NAME | INS-NEW | DEL-DEL
Main Page | File Page | Param Page | DDCSV3.1@DDREAM

Figure 3-11 Delete the 2mmnew.tap file

4) Load the G code file

Highlight the G code file required and click . The file will be loaded and the screen will change back to the Main Screen for processing. The file name will be displayed.

STEP	READY	2mmnew.tap	00:00:00
Name	Size	Time	
..	[DIR]	1970/01/09 08:18	
file	[DIR]	1970/01/09 08:18	
install	[DIR]	1970/01/09 08:18	
new-1.nc	0	1970/01/01 00:46	
BMP10.bmp	261174	1980/01/01 00:00	
BMP11.bmp	261174	1980/01/01 00:00	
BMP12.bmp	261174	1980/01/01 00:00	
2mmnew.tap	1525365	2018/07/15 17:12	

F1-COPY | F2-PASTE | F3-EDIT | F4-NAME | INS-NEW | DEL-DEL
Main Page | File Page | Param Page | DDCSV3.1@DDREAM

Figure 3-12 Search for the file2mmnew.tap and load

AUTO	BUSY	2mmnew.tap	00:00:11
X	38.902	38.902 mm	FRO: 100%
Y	-50.025	-50.025 mm	SRO: 100%
Z	-1.471	-1.471 mm	SJR 0.01
A	0.000	0.000	F 0 3000
95: X39.161Z-1.472			S 13999 14000
Main Page File Page Param Page			G54 M3 M9 M11
			Normal Mod
			Ver:2019-04-25-107NOR
			DDCSV3.1@DDREAM


Figure 3-13 After loading the file 2mmnew.tap the file name will be displayed

For the keyboard operation keys, beside copy paste and delete, users can also operate it as following functions:

- F3 Edit: Edit a G Code file;
- F4: Can name a file;
- INS NEW: Create a new .nc file.





3.3.2 Running a G code file

3.3.2.1 Start running G code





Before loading the G code file, make sure the controller is in READY. If RESET is blinking, just press the  key and ensure the operation status column displays READY.

Now set ZERO as requested. For example, if the G code file defines the work piece center as the XY ZERO point, move the cutter to that position.


Click the  button and then click the  button. The Operation Window will give you several options. Click  and an EDIT WINDOW will open. Click  to Zero X.

Click the  button again and then click the  button. Now click  to select Y Axis and an EDIT WINDOW will open. Click  to Zero Y.

Before starting the G-code the user must set the tool to the correct height and Zero the Z axis.

After loading the G-code file, press  to run the G code file. During G code processing, only the function of  and  are valid. The  key can set the values of FRO

See Figure 3-13.

Look at Current Operation (just below the Axis Read Out). It shows that the G code file is processing . The controller now is in BUSY Mode. Press  to switch the display to show the tool path. Figure3-14,15 and 16 show the tool path display.

AUTO	BUSY	2mmnew.tap	00:00:19
X	37.402	mm	FRO: 100%
	37.402		SRO: 100%
Y	-50.025	mm	SJR 0.01
	-50.025		F 213 99999
Z	4.654	mm	S 13999 14000
	4.654		G54 M3 M9 M11
A	0.000		Normal Mod
	0.000		Ver:2019-04-25-107NOR
96: X39.161Z-1.472			
Main Page	File Page	Param Page	DDCSV3.1@DDREAM

Figure 3-14 G code is processing

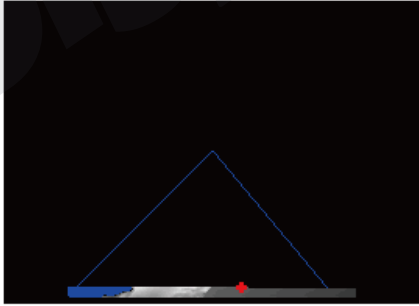
AUTO	BUSY	2mmnew.tap	00:00:52
			FRO: 100%
			SRO: 100%
			SJR 0.01
			F 1935 3000
			S 13999 14000
			G54 M3 M9 M11
			Normal Mod
1121: X15.830Z-1.309			Ver:2019-04-25-107NOR
Main Page	File Page	Param Page	DDCSV3.1@DDREAM

Figure 3-15 Tool path display after processing at beginning of the file

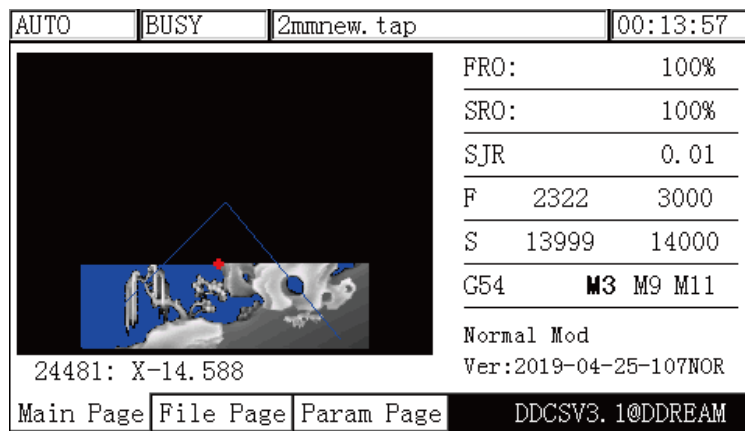


Figure 3-16 Tool path display after processing 1/3 of the file

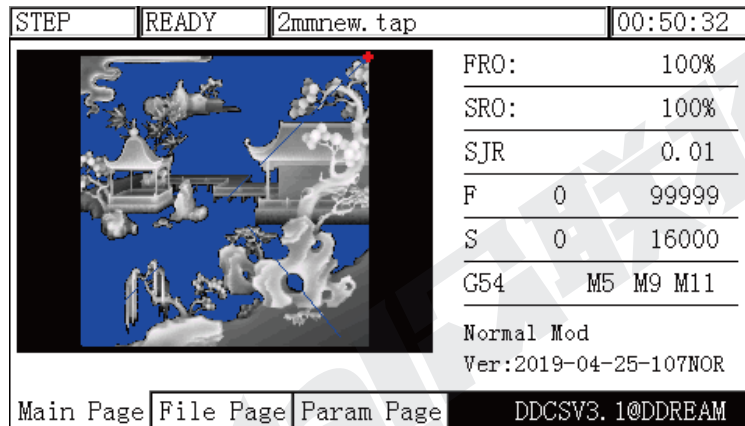





Figure 3-17 Tool path display, processing completed

3.3.2.2 Breakpoint operation




Press  to enter the second-Function(2nd) mode. Click  to enter the breakpoint operation. The controller will run from the last recorded breakpoint.

Note:When you click , it will automatically produce a breakpoint. In case of power outage, it will also automatically record the breakpoint. As the Figure 3-18 shows, it begins processing from the 255th line at this time. Figure 3-18 shows the display under the “goto break” status and the display shows the file name.

STEP	READY	2mmnew.tap	00:00:17
X	-5.173	-5.173 mm	FRO: 100%
Y	-49.625	-49.625 mm	SRO: 100%
Z	4.140	4.140 mm	SJR 0.01
A	0.000	0.000	F 0 99999
255: X-5.225Z-0.869			S 13999 16000
Main Page File Page Param Page			G54 M3 M9 M11
			Normal Mod
			Ver:2019-04-25-107NOR
			DDCSV3.1@DDREAM

Figure 3-18 Breakpoint Operation

3.3.2.3 Start a G code file from a specific line

Click  to enter the 2nd mode. When in 2nd mode, click  and the Start Line Edit Box will appear. Insert the line number and click . A syntax check will be performed and the G code will be operated from your chosen Start Line position. See Figures 3-19 to 3-21.

2ND	READY	2mmnew.tap	00:00:33
X	-33.507	-33.507 mm	FRO: 100%
Y	-46.625	-46.625 mm	SRO: 100%
Z	3.001	3.001 mm	SJR 0.01
A	0.000	0.000	F 0 99999
Start Line: 0000010			S 13999 16000
Main Page File Page Param Page			G54 M3 M9 M11
			X+:left X-:right Y+:up
			Z-:enter Z+:cancel
			DDCSV3.1@DDREAM

Figure 3-19 Edit the start line

2ND	READY	2mmnew.tap	00:00:11
X	49.565	49.565 mm	FRO: 100%
Y	-47.025	-47.025 mm	SRO: 100%
Z	3.499	3.499 mm	SJR 0.01
A	0.000	0.000	F 0 99999
1138: X47.904Z-1.492			S 13999 16000
Main Page File Page Param Page			G54 M3 M9 M11
			X-:gotoz Y-:zero Z-:hom
			A-:probe Start:goto bre
			DDCSV3.1@DDREAM

Figure 3-20 Syntax Checking

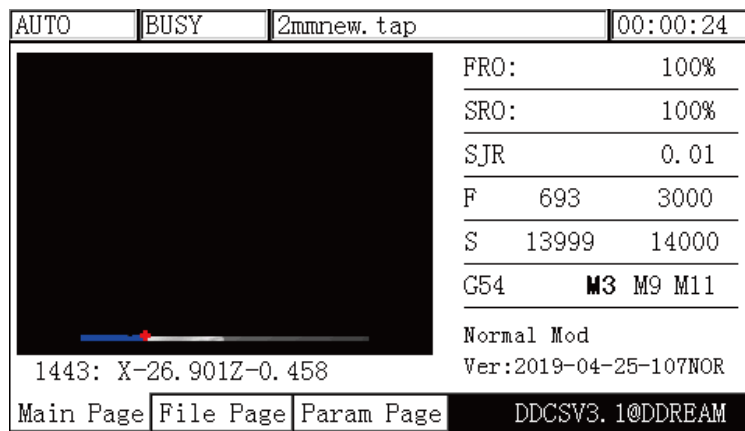


Figure 3-21 Program will run from the chosen line


3.3.2.4 Pause in operation

During file processing, press the  key to pause the operation. The Operation Status Column will display “READY” and the Z axis will lift the tool to the defined safe height.


3.3.2.5 ESTOP in operation

During file processing, press the  key to ESTOP the procedure. The Operation Status Column will display “RESET” flashing. The spindle will stop.





3.3.2.6 Start/Stop spindle

Only when the Operation Status Column displays “READY” you can manually start or stop the spindle. Use  the spindle button to switch from Start to Stop and back.

3.3.3 Manually position the machine



You can manually position the machine at any position. You can move Continuously, in defined Steps or with the MPG. The  button moves you through the three options:

3.3.3.1 Manually step the X axis

Press **Mode** till “step” is displayed. In Figure 3-22 Step parameter shows the current step rate (0.01mm). Press the **Tab** button till SJR is highlighted and you can change the steps by the key  and . Press the  key to move the X axis negative 0.01mm, and press the key  to move the X axis 0.01mm positive. Move Y Z and A in the same way.

STEP	READY	2mmnew.tap	00:00:00
X	0.000	0.000 mm	FRO: 100%
Y	0.000	0.000 mm	SRO: 100%
Z	5.000	5.000 mm	SJR 0.01
A	0.000	0.000	F 0 99999
			S 0 16000
			G54 M5 M9 M11
			Normal Mod
			Ver:2019-04-25-107NOR
Main Page	File Page	Param Page	DDCSV3.1@DDREAM



Figure 3-22 STEP Mode

Using the parameter setting page (see section 4), the step distance for each axis can be set in parameters “#2020”, “#2021”, “#2022”, “#2023”. Press  and  the two keys to shift the four setting values.

The detailed setting information Please check the Parameters Page.

3.3.3.2 Continuous operation of the X axis

Click **Mode** till CONT is displayed. The feed status displays “CONT”. See Figure 3-23. You can now move the axis continuous with the arrow keys.

Adjust the Jog speed by highlighting SJR and modify the jog speed with  and . All other axes can be moved in the same way.

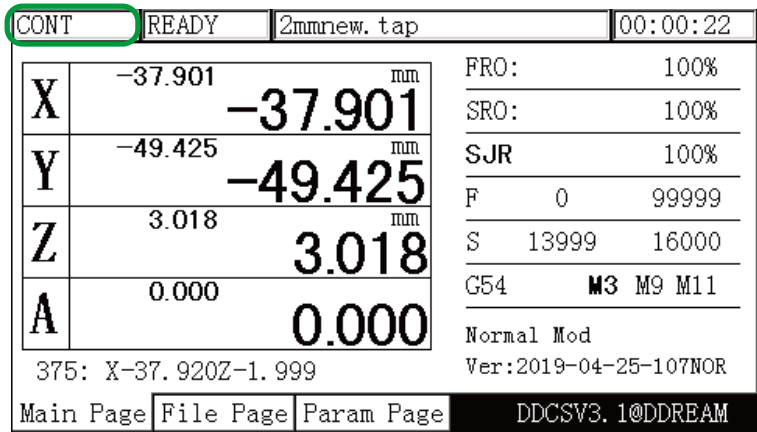



Figure 3-23 Enter the manual Continuously moving mode

3.3.3.3 Use MPG to operate X axis

Click  till the Feed Status displays “MPG”. Choose the X channel on MPG and select the rate, then turn handwheel, the X axis can be moved.

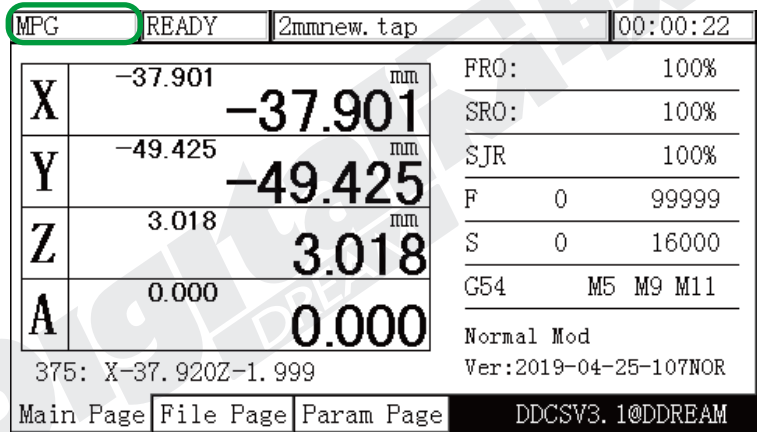


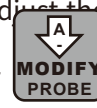


Figure 3-24 Enter the MPG mode

3.3.4 Main Page Parameter adjustments



The values FRO, SRO, SJR, F, S Coordinate system can be easily changed.

Click  till the display highlights, and when you want to adjust the settings of “FRO”, “SRO”, “SJR” and Coordinate Selection just press the keys  or  ;

When you want to change the value of F and S, Press  to modify the values and put in new number by the keys of  and  , and also you can put numbers by keyboard.

3.3.4.1 Adjust FRO Value

The FRO parameters. Under “READY” press  till FRO is highlighted (bold).



With  and  adjust the value between 0% to 300%.When the controller is running a G-code file,the users can also adjust this value.

CONT	READY	2mmnew.tap	00:00:22
X	-37.901	-37.901 mm	FRO: 120%
Y	-49.425	-49.425 mm	SRO: 100%
Z	3.018	3.018 mm	SJR 100%
A	0.000	0.000	F 0 99999
375: X-37.920Z-1.999			S 0 16000
Main Page File Page Param Page			G54 M5 M9 M11
			Normal Mod
			Ver:2019-04-25-107NOR
			DDCSV3.1@DDREAM

Figure 3-25 SJR value adjusts to 10 under the mode of “step”

3.3.4.2 Adjust SRO Value

Press  to enter the SRO adjusting Value status.

The Spindle adjustment controls the spindle’s speed. Highlight SRO and use the key  and  to adjust the spindle speed from 0% to 200%.



CONT	READY	2mmnew.tap	00:00:22
X	-37.901	-37.901 mm	FRO: 120%
Y	-49.425	-49.425 mm	SRO: 120%
Z	3.018	3.018 mm	SJR 100%
A	0.000	0.000	F 0 99999
375: X-37.920Z-1.999			S 0 16000
Main Page File Page Param Page			G54 M5 M9 M11
			Normal Mod
			Ver:2019-04-25-107NOR
			DDCSV3.1@DDREAM

Figure 3-26 Shift to SRO Adjusting Mode

3.3.4.3 Adjust SJR Value

The SJR is to adjust the jog speed. The Jog Speed is set by #100~#103 in Param Page.

In “CONT” mode you can adjust from 0% to 150%;

In “Step” mode you can shift to 4 different distance as you defined, the distance must be set by #2020, #2021, #2022, #2023 in Param Page. Use  and  to choose your value.

Click on the Axes arrow keys will move the machine this distance once.

CONT	READY	2mmnew.tap	00:00:22
X	-37.901	-37.901 mm	FRO: 120%
Y	-49.425	-49.425 mm	SRO: 120%
Z	3.018	3.018 mm	SJR: 80%
A	0.000	0.000	F 0 99999
			S 0 16000
			G54 M5 M9 M11
375: X-37.920Z-1.999			Normal Mod
			Ver:2019-04-25-107NOR
Main Page	File Page	Param Page	DDCSV3.1@DDREAM

Figure 3-27 In CONT mode SJR value adjusts to 80%

CONT	READY	2mmnew.tap	00:00:22
X	-37.901	-37.901 mm	FRO: 120%
Y	-49.425	-49.425 mm	SRO: 120%
Z	3.018	3.018 mm	SJR: 120%
A	0.000	0.000	F 0 99999
			S 0 16000
			G54 M5 M9 M11
375: X-37.920Z-1.999			Normal Mod
			Ver:2019-04-25-107NOR
Main Page	File Page	Param Page	DDCSV3.1@DDREAM

Figure 3-28 In CONT mode SJR value increased to 120%

STEP	READY	2mmnew.tap	00:00:22
X	-37.901	-37.901 mm	FRO: 100%
Y	-49.425	-49.425 mm	SRO: 100%
Z	3.018	3.018 mm	SJR 1
A	0.000	0.000	F 0 99999
375: X-37.920Z-1.999			S 0 16000
Main Page File Page Param Page			G54 M5 M9 M11
			Normal Mod
			Ver:2019-04-25-107NOR
			DDCSV3.1@DDREAM

Figure 3-29 In STEP mode SJR value shifted to the self-defined distance

3.3.4.4 F Value modification

The F value is the default Feed Speed. Use the **Tab** key to highlight F.



If you click , the Edit Window will appear. Use the  and  keys to

choose your feed speed and confirm with Enter. See Figure 3-30 and 3-34. You can also use the keyboard to input the numbers.

CONT	READY	2mmnew.tap	00:00:22
X	-37.901	-37.901 mm	FRO: 100%
Y	-49.425	-49.425 mm	SRO: 100%
Z	3.018	3.018 mm	SJR 100%
A	0.000	0.000	F 0 99999
375: X-37.920Z-1.999			S 0 16000
Main Page File Page Param Page			G54 M5 M9 M11
			Normal Mod
			Ver:2019-04-25-107NOR
			DDCSV3.1@DDREAM

Figure 3-30 F is highlighted then we can adjust the F value

When edit the value, you can use  and  to find number position

and use  and  to increase or decrease the number;

Use  to cancel the setting and use  to confirm and enter the setting.

All this can be done by keyboard.

STEP	READY	2mmnew.tap	00:00:22
X	-37.901	-37.901 mm	FRO: 100%
Y	-49.425	-49.425 mm	SRO: 100%
Z	3.018	3.018 mm	SJR 1
A	0.000	0.000	F 0 99999
375: X-37.920Z-1.999			S 0 16000
Main Page File Page Param Page			G54 M5 M9 M11
			Normal Mod
			Ver:2019-04-25-107NOR
			DDCSV3.1@DDREAM


Figure 3-31 F is highlighted

STEP	READY	2mmnew.tap	00:00:22
X	-37.901	-37.901 mm	FRO: 100%
Y	-49.425	-49.425 mm	SRO: 100%
Z	3.018	3.018 mm	SJR 1
A	0.000	0.000	F 0 3000
375: X-37.920Z-1.999			S 0 16000
Main Page File Page Param Page			G54 M5 M9 M11
			X+:left X-:right Y+:up
			Z-:enter Z+:cancel
			DDCSV3.1@DDREAM

Figure 3-32 Press Modify Key to edit the value

STEP	READY	2mmnew.tap	00:01:41
X	-37.901	-37.901 mm	FRO: 100%
Y	-49.425	-49.425 mm	SRO: 100%
Z	-3.018	-3.018 mm	SJR 1
A	0.000	0.000	F 0 3000
375: X-37.920Z-1.999			S 0 16000
Main Page File Page Param Page			G54 M5 M9 M11
			Normal Mod
			Ver:2019-04-25-107NOR
			DDCSV3.1@DDREAM

Figure 3-33 The F Value is set to 3000




When “F” is highlighted,press the key ,it can make the F value highlighted too.That means the system current F value is not from G-code file,this highlighted value is the running feeding speed.As Figure 3-34 shows,

STEP	READY	2mmnew.tap	00:00:22
X	-37.901	-37.901 mm	FRO: 100%
Y	-49.425	-49.425 mm	SRO: 100%
Z	3.018	3.018 mm	SJR 1
A	0.000	0.000	F 0 3000
375: X-37.920Z-1.999			S 0 16000
Main Page File Page Param Page			G54 M5 M9 M11
			Normal Mod
			Ver:2019-04-25-107NOR
			DDCSV3.1@DDREAM

Figure 3-34 Press A+ and set the F value as the current feeding speed

3.3.4.5 S Value modification



The S value is the default spindle Speed. Use the  key to highlight S.

If you click , the Edit Window will appear. Use the  and  keys to choose your Spindle speed and confirm with Enter. See Figure 3-35 to 3-37. You can also use the keyboard to input the numbers.

STEP	READY	2mmnew.tap	00:00:22
X	-37.901	-37.901 mm	FRO: 100%
Y	-49.425	-49.425 mm	SRO: 100%
Z	3.018	3.018 mm	SJR 1
A	0.000	0.000	F 0 3000
375: X-37.920Z-1.999			S 0 16000
Main Page File Page Param Page			G54 M5 M9 M11
			Normal Mod
			Ver:2019-04-25-107NOR
			DDCSV3.1@DDREAM

Figure 3-35 S is highlighted then we can adjust the F value

When edit the value, you can use  and  to find number position

and use  and  to increase or decrease the number;

Use  to cancel the setting and use  to confirm and enter the setting.

All this can be done by keyboard.

STEP	READY	2mmnew.tap	00:00:22
X	-37.901	-37.901 mm	PRO: 100%
Y	-49.425	-49.425 mm	SRO: 100%
Z	3.018	3.018 mm	SJR 1
A	0.000	0.000	F 0 3000
375: X-37.920Z-1.999			S 0 15000
Main Page File Page Param Page			G54 M5 M9 M11
			X+:left X-:right Y+:up Z-:enter Z+:cancel
			DDCSV3.1@DDREAM



Figure 3-36 Press Modify Key to edit the value

STEP	READY	2mmnew.tap	00:00:22
X	-37.901	-37.901 mm	PRO: 100%
Y	-49.425	-49.425 mm	SRO: 100%
Z	3.018	3.018 mm	SJR 1
A	0.000	0.000	F 0 3000
375: X-37.920Z-1.999			S 0 7700
Main Page File Page Param Page			G54 M5 M9 M11
			Normal Mod
			Ver:2019-04-25-107NOR
			DDCSV3.1@DDREAM

Figure 3-37 Press A+ and set the S value as the current spindle speed

3.3.4.6 Select G coordinate system

Under “READY”, press the **Tab** key till the Coordinate System is highlighted. It will display G54,G59 or **MACH** (Machine Coordinates).

Use  and  to choose your desired Coordinate System. Position values will be displayed for X, Y, Z and A. The Enter key confirms the Coordinate System you chose.

STEP	READY	2mmnew.tap	00:00:22
X	-37.901	-37.901 mm	FRO: 100%
Y	-49.425	-49.425 mm	SRO: 100%
Z	3.018	3.018 mm	SJR 1
A	0.000	0.000	F 0 3000
375: X-37.920Z-1.999			S 0 7700
Main Page File Page Param Page			G54 M5 M9 M11
			Normal Mod
			Ver:2019-04-25-107NOR
			DDCSV3.1@DDREAM

Figure 3-38 G54 Current coordinate system

STEP	READY	2mmnew.tap	00:00:22
X	-37.901	-37.901 mm	FRO: 100%
Y	-49.425	-49.425 mm	SRO: 100%
Z	3.018	-77.884 mm	SJR 1
A	0.000	0.000	F 0 3000
375: X-37.920Z-1.999			S 0 7700
Main Page File Page Param Page			G55 M5 M9 M11
			Normal Mod
			Ver:2019-04-25-107NOR
			DDCSV3.1@DDREAM


Figure 3-39 G55 Current coordinate system

STEP	READY	2mmnew.tap	00:00:22
X	-37.901	-37.901 mm	FRO: 100%
Y	-49.425	-49.425 mm	SRO: 100%
Z	3.018	3.018 mm	SJR 1
A	0.000	0.000	F 0 3000
375: X-37.920Z-1.999			S 0 7700
Main Page File Page Param Page			MACH M5 M9 M11
			Normal Mod
			Ver:2019-04-25-107NOR
			DDCSV3.1@DDREAM

Figure 3-40 MACH Current coordinate system

3.3.5 The 2ND Mode

The 2nd key opens several functions.


In READY mode, the Operation Window displays “Normal Mode”. Press  to enter the 2nd mode. The Operation Window will show: X-:gotoz Y-:zero Z-: home A-:probe start:goto break and the Feed Status column displays “2ND”. See Figure 3-41. You can now make your choice which may open new options accordingly.

2ND	READY	2mmnew.tap	00:00:22
X	-37.901	-37.901 mm	FRO: 100%
Y	-49.425	-49.425 mm	SRO: 100%
Z	3.018	3.018 mm	SJR 1
A	0.000	0.000	F 0 3000
375: X-37.920Z-1.999			S 0 7700
Main Page File Page Param Page			G54 M5 M9 M11
			X-:gotoz Y-:zero Z-:home
			A-:probe Start:goto break
			DDCSV3.1@DDREAM

Figure 3-41 2ND Mode

3.3.5.1 Go To Zero

In Ready Mode, Press the key  to enter into the 2ND Mode.

Press  one time, the system turns to go to zero mode, as Picture 3-42 shows.

GOTOZ	READY	2mmnew.tap	00:00:22
X	-37.901	-37.901 mm	FRO: 100%
Y	-49.425	-49.425 mm	SRO: 100%
Z	3.018	3.018 mm	SJR 1
A	0.000	0.000	F 0 3000
375: X-37.920Z-1.999			S 0 7700
Main Page File Page Param Page			G54 M5 M9 M11
			X-:all gotoz X+:x gotoz
			Y+:y gotoz Z+:z gotoz
			DDCSV3.1@DDREAM





Figure 3-42 Turns to Go To Zero Mode

In Go To Zero Mode, there are two options. The users can make all Axis Go to Zero, also can choose one single axis Go To Zero.

A: Single Axis Go To Zero:

Press the keys of  or  or  or  to select the axis. Lets' s take the

X axis as the example:

After pressing  to go to 2nd Mode, and pressing  to go to the Go To Zero mode, then we press  to select X axis to go to zero, an value editing window will show up as Figure 3-43. If just press the enter key , will just Go to Zero. If put a number, for example 100, then confirm and press Enter, X axis will than move position to 100 in current coordinate system.

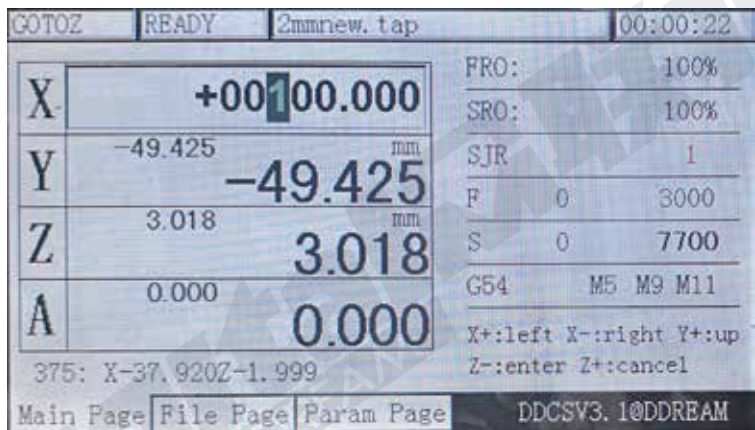


Figure 3-43 In X axis Go To Zero Mode put the X go to 100

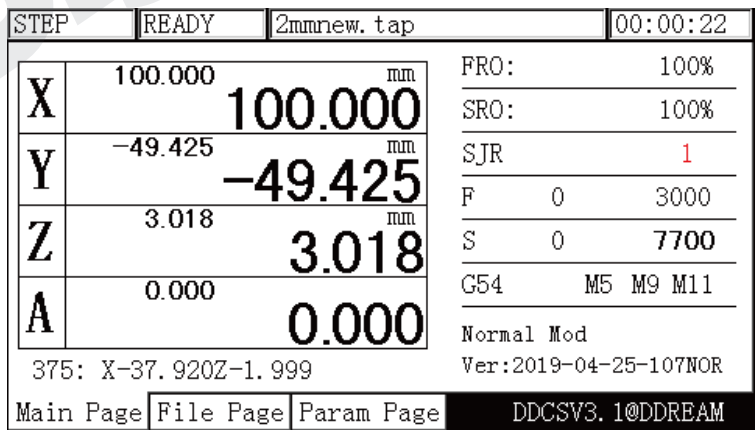





Figure 3-44 X Axis runs to 100 after "gotoz" action

B: All Axes Go To Zero:

After pressing  to go to 2nd Mode, and pressing  to go to the Go To Zero mode, then we just press  again to let all axes go to zero. Then there is no editing window pop up, system just do the action of all the axes “Go To Zero”.


STEP	READY	2mmnew. tap	00:09:27
X	0.000	0.000 mm	FRO: 100%
Y	0.000	0.000 mm	SRO: 100%
Z	5.000	5.000 mm	SJR 1
A	0.000	0.000	F 0 3000
375: X-37.920Z-1.999			S 0 7700
Main Page File Page Param Page			G54 M5 M9 M11
			Normal Mod
			Ver:2019-04-25-107NOR
			DDCSV3.1@DDREAM

Figure 3-45 All Axis Go To Zero

Note: “All Axes Go To Zero” will not zero Z axis, Z will go to a safety height as defined by parameter #82.

3.3.5.2 Zero

In Ready Mode, Press the key  to enter into the 2ND Mode.





Press  one time, the system turns to Zero mode, as Picture 3-46 shows.






ZERO	READY	2mmnew. tap	00:10:07
X	1.250	1.250 mm	FRO: 100%
Y	-47.625	-47.625 mm	SRO: 100%
Z	3.777	3.777 mm	SJR 1
A	0.000	0.000	F 0 3000
990: X2.483Z-1.236			S 7699 7700
Main Page File Page Param Page			G54 M3 M9 M11
			Y-:all zero X+:x zero
			Y+:y zero Z+:z zero
			DDCSV3.1@DDREAM

Figure 3-46 Zero Mode

In Zero Mode, there are two options. The users can Zero all Axes, also can Zero selected single axis.

A: Zero selected single axis:

Press the keys of  or  or  or  to select the axis. Let's take the X axis as the example:

After pressing  to go to 2nd Mode, and pressing  to go to the Zero mode, then we press  the Key  to select X axis to Zero X axis, an value editing window will show up as Figure 3-47. If just press the enter key  just go to Zero. If put in a number, for example 100, then confirm and press Enter, the system will set the current position of X axis is 100 in current coordinate system, see Figure 3-48.

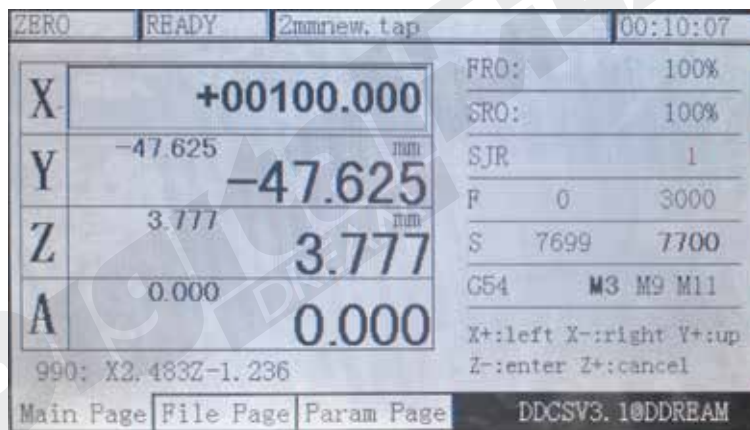


Figure 3-47 In Zero X axis put the the number as 100

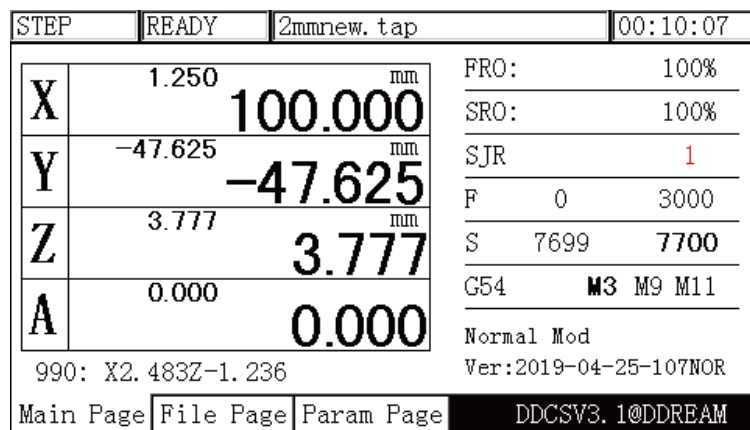





Figure 3-48 Set the current X Axis position as 100 in current coordinate

B: Zero All Axes:


After pressing  to go to 2nd Mode, and pressing  to go to the Go To Zero mode, then we just press  again to Zero All axes. Then there is no editing window come up, system just do the action of all the axes "Zero".

CONT	READY	2mmnew. tap	00:00:00
X	49994.156	0.000 mm	FRO: 100%
Y	25.175	0.000 mm	SRO: 100%
Z	26.207	0.000 mm	SJR 100%
A	10.066	0.000	F 0 99999
			S 0 16000
			G54 M5 M9 M11
			Normal Mod
			Ver:2019-04-25-107NOR
Main Page	File Page	Param Page	DDCSV3.1@DDREAM

Figure 3-49 Zero All Axes

3.3.5.3 Home

In Ready Mode, Press the key  to enter into the 2ND Mode.

Press  one time, the system turns to Home mode, as Picture 3-50 and 3-51 show.

2ND	READY	2mmnew. tap	00:13:38
X	-17.675	-17.675 mm	FRO: 100%
Y	-47.225	-47.225 mm	SRO: 100%
Z	4.429	4.429 mm	SJR 1
A	0.000	0.000	F 0 3000
			S 7699 7700
			G54 M3 M9 M11
			X-:gotoz Y-:zero Z-:home
			A-:probe Start:goto bre
1087: X-16.813Z-0.585			
Main Page	File Page	Param Page	DDCSV3.1@DDREAM

Figure 3-50 2ND Mode

HOME	READY	2mmnew.tap	00:13:38
X	-17.675	-17.675 mm	FRO: 100%
Y	-47.225	-47.225 mm	SRO: 100%
Z	4.429	4.429 mm	SJR 1
A	0.000	0.000	F 0 3000
1087: X-16.813Z-0.585			S 7699 7700
Main Page File Page Param Page			G54 M3 M9 M11
			Z-:all home X+:x home Y+:y home Z+:z home
			DDCSV3.1@DDREAM





Figure 3-51 Home Mode

In Home Mode, there are two options. The users can Home all Axes, also can Home selected single axis.

A: Home selected single axis:

Press the keys of  or  or  or  to select the axis. Let's take the




X axis as the example:

After pressing  to go to 2nd Mode, and pressing  to go to the Zero mode, then we press the Key  to select X axis to Home X axis, press the enter key , the system will start to run the X axis to find the Home switch until the switch is triggered, then it will stop and turn back a little distance, that is back distance, can be set by #83, #84, #85, #86 for each axis in Param Page. For our example the X axis will run back 10mm. Then the X axis Homing action finished, see the Figure 3-52.

STEP	READY	2mmnew.tap	00:13:38
X	10.000	10.000 mm	FRO: 100%
Y	-47.225	-47.225 mm	SRO: 100%
Z	4.429	4.429 mm	SJR 1
A	0.000	0.000	F 0 3000
1087: X-16.813Z-0.585			S 7699 7700
Main Page File Page Param Page			G54 M3 M9 M11
			Normal Mod
			Ver:2019-04-25-107NOR
			DDCSV3.1@DDREAM

Figure 3-52 X axis Homing

B: Home All Axes:

After pressing  to go to 2nd Mode, and pressing  to go to the Home mode, then we just press  again to Home All axis. The System will Home Z axis Firstly, then X/Y/A sequentially.

STEP	READY	2mmnew. tap	00:13:38
X	10.000	10.000 mm	FR0: 100%
Y	10.000	10.000 mm	SRO: 100%
Z	10.000	10.000 mm	SJR 1
A	0.000	0.000	F 0 3000
		1087: X-16.813Z-0.585	S 7699 7700
			G54 M3 M9 M11
			Normal Mod
			Ver:2019-04-25-107NOR
Main Page File Page Param Page			DDCSV3.1@DDREAM

Figure 3-53 All Axis Homing

3.3.5.4 Probe



The cutters will be worn down after long time working, or during the processing the users need to change another cutters to finish job, we need to measure the new position of the cutter point. Then we need the action of Probe to find new position. In our new version V3.1, we have 3 kinds probe methods:

#68=1: Mode 1, Probe of Fixed Position of Tool Sensor;

#68=2: Mode 2, Probe of Floating Tool Sensor;

#68=3: Mode 3, Probe of rectangular block Sensor, by this methods it can probe X/Y/Z 3 axes.

If #68 set to 0, then the probe function is forbidden.

After pressing  to go to 2nd Mode, and pressing  to go to the Probe mode.

PROBE	READY	2mmnew. tap	00:13:38
X	10.000	10.000 mm	FR0: 100%
Y	10.000	10.000 mm	SRO: 100%
Z	10.000	10.000 mm	SJR 1
A	0.000	0.000	F 0 3000
		1087: X-16.813Z-0.585	S 7699 7700
			G54 M3 M9 M11
			A-:go probe
Main Page File Page Param Page			DDCSV3.1@DDREAM

Figure 3-54 Probe Mode

A: #68=1: Probe of Fix Position Tool Sensor

This mode uses 2 probe sequences to first establish the height of the tool sensor and then probes the tool onto the sensor. In so doing it updates the value held in #69 ["Thickness of tool sensor"].

It uses the following parameters:

#69 ["Thickness of tool sensor"] It updates this parameter with the measured tool height.

Note that this parameter can have a negative value:

It measures the "height" of the tool probe comparing the stock z-zero (defined during the zeroing sequence) and z coordinate during the tool contact with the sensor. So depending on the work setup (tool probe surface is higher or lower then the stock/code z-zero) - it could be both positive and negative, as it's not a real probe height - it's a difference between part/stock zero and surface of the probe.

#71 ["Initial tool's position"]

0 = "current position" Where the probe is in the current reference frame. All examples relate to G54

1 = "fixed position" The position of the tool sensor in the MACH machine Coordinate

If "fixed" it uses:

These 3 locate the tool sensor in the Machine co-ordinate system (MACH)

#72 ["Initial probe position on X axis"]

#73 ["Initial probe position on Y axis"]


#74 ["Initial probe position on Z axis"]


#75 ["back distance after probe"] How far to retract in Z after the contact

Operations:

Step1: The user has to manually zero the z axis onto the tool table;

Step2: To measure the thickness of the sensor(#69 ["Thickness of tool sensor"]):

If #71=0,then move the Z axis manually onto the sensor,then press  twice,the system start to probe.

If #71=1,and #72,#73,#74 already set a value,press the key  twice,the system will move the Z axis to the positon of Mach coordinate and probe.

Then the #69 ["Thickness of tool sensor"] can have a number in system.

Step3: Change a new cutter or in the situation you need to find Z positon again,do the probe action again,then you can find the Z position.

Please note when you build a new coordiante(for example zero all axis),the #69 value will become 0,you will have to probe twice.

B: #68=2: Probe of Floating Tool Sensor

This mode is the simplest. It uses the height of the tool sensor and the retract distance after the probe to set the Z height of the tool.

It uses the following parameters:

#69 ["Thickness of tool sensor"] How high is the tool sensor in the Z axis.

#71 ["Initial tool's position"]

0 = "current position" Where the probe is in the current reference frame. All examples relate to G54

1 = "fixed position" The position of the tool sensor in the MACH machine space

If "fixed" it uses:

These 3 locate the tool sensor in the Machine co-ordinate system (MACH)

#72 ["Initial probe position on X axis"]

#73 ["Initial probe position on Y axis"]

#74 ["Initial probe position on Z axis"]

#75 ["back distance after probe"] How far to retract in Z after the contact

Operations:

Step1: The user has to manually zero the z axis onto the tool table;

Step2: Measure the thickness of the sensor, and input the value of #69 in Param Page;

Step3: Press  into 2ND and Press  two times the system start to Probe.

Please note when you build a new coordinate (example zero all axes), the #69 value will become 0.

Typically the probe and its target consist of an isolated metal plate and the probe itself. The probe could be a metallic object held in the chuck and connected to one of the probe wires. The target is a metal plate insulated from the machine bed. The probe Redwire is connected to pin 4[Probe] and the plate is connected to pin 1[COM-] on the third layer terminal. The crocodile clip is attached to the probe or other part of the machine.

The tool sensor as following is good for Probe Mode 1 and 2:



C: #68=3 Probe of Rectangular Block,by this methods it can probe X/Y/Z 3 axes.

This mode is the most complex and useful as it probes all three axes. In order for this the tool sensor must be a cube or similar regular rectangular block. The mode will first probe for Z, then probe the side of the block [left or right] for X and finally it will probe the face or the back of the block for Y. It then retracts back as dictated by parameter #75 and moves to the X & Y zero position as defined by #2001 and #2002.

Note if you want to locate onto the corner you just probed set #2001 and #2002 to 0.

Note:

#69 is NOT used

#71 is NOT used in this mode

#75 is NOT used in this mode

It uses the following parameters:

#2000 ["Cutter diameter"] The diameter of the probe tip

#2001 ["Tool plate thick for X"]

#2002 ["Tool plate thick for Y"]

#2003 ["Tool plate thick for Z"]

#2004 ["shift of X axis before probed"] If Positive it will probe the right hand side of the block.

#2005 ["shift of Y axis before probed"] If negative it will probe the front face of the block

#2006 ["Z position before X(Y)-axis probed"] The distance to descend before moving the X or Y axes to establish probe contact

#2007 ["Back distance when the tool touches the X-axis edge"] After an axis is touched off these 3 parameters

#2008 ["Back distance when the tool touches the Y-axis edge"] define how much to pull back before the next

#2009 ["Back distance when the tool touches the Z-axis edge"] movement

#2010 ["center of tool plate"] If you want to set the X & Y zero to the corner of the test block you would set #2001 & #2002 to 0. Refer to Figure 67, and if this is the case when #2010 = 0 the tip of the tool has to be exactly on the corner. If you set #2010 to a value, the tool is offset (in X) when probing for Y. This should lead to better accuracy.

#2011 ["Probe feedrate"] The feed rate to be used when probing. Probing is done by a G01 command in relative (G91) mode.

In order for this the tool sensor must be a conductive cube isolated from the machines table. It could be a piece of insulating material with 3 conductive corners as shown in Figure 3-55 or a metal cube sitting on top of an insulator as shown in Figure 3-57.

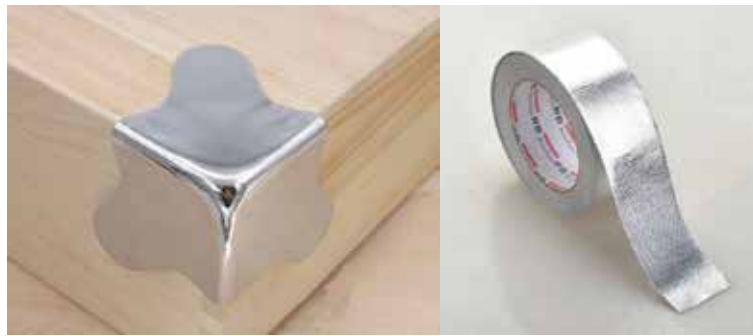


Figure 3-55 A piece of insulating material with 3 conductive corners as the Tool sensor for probe mode 3

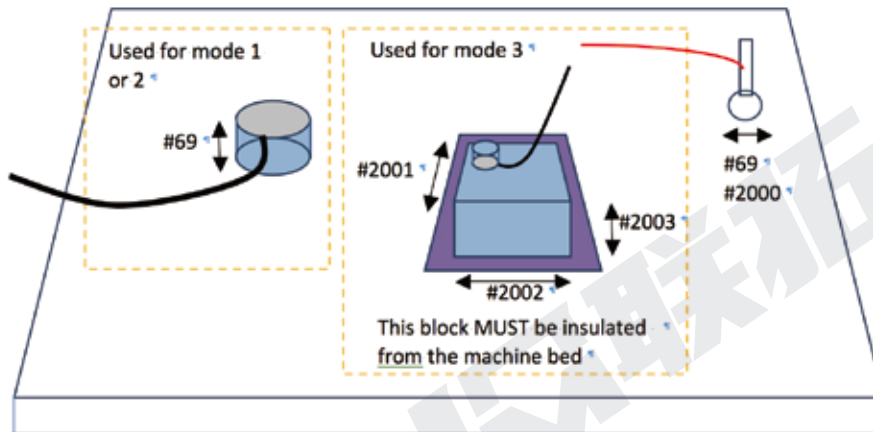


Figure 3-56 Basic parameter definitions

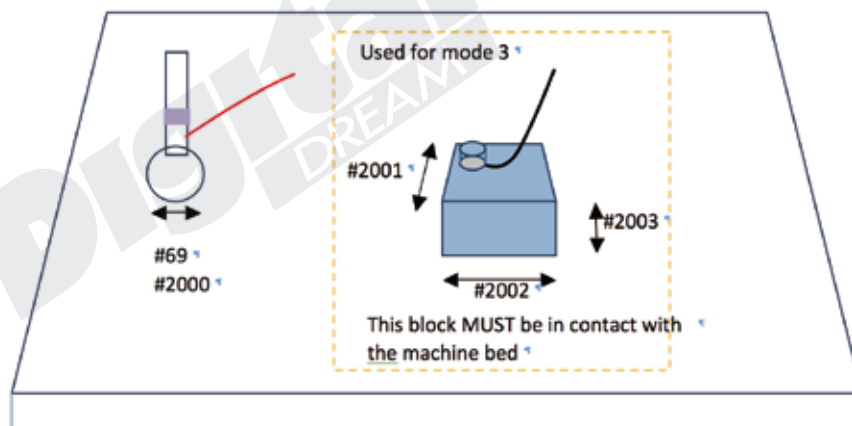


Figure 3-57 Mode 3 alternative isolated Probe tip

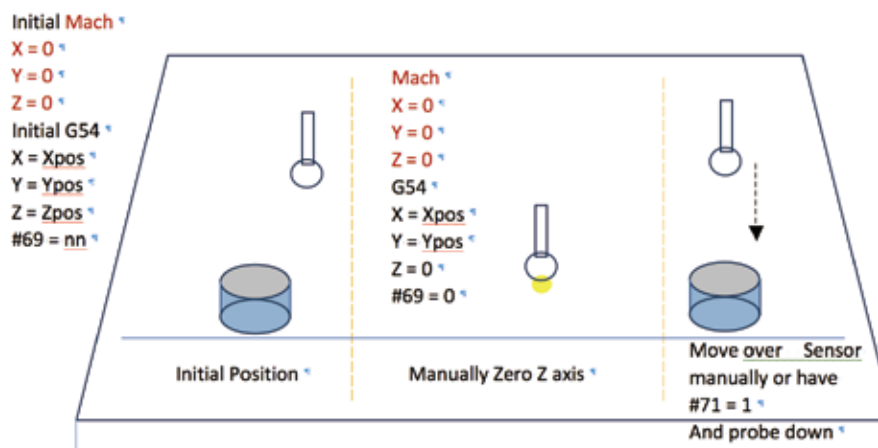


Figure 3-58 Mode 1 Probing Sequence for Z axis: go to the position where start to probe manually or by #71=1

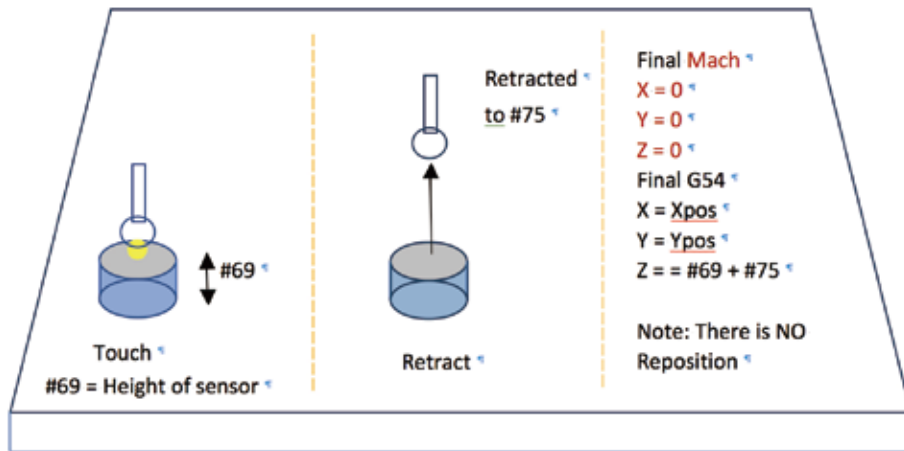


Figure 3-59 Mode 1 Probing Sequence for Z axis: First Probe and get the #69, then second Probe to get Z Position

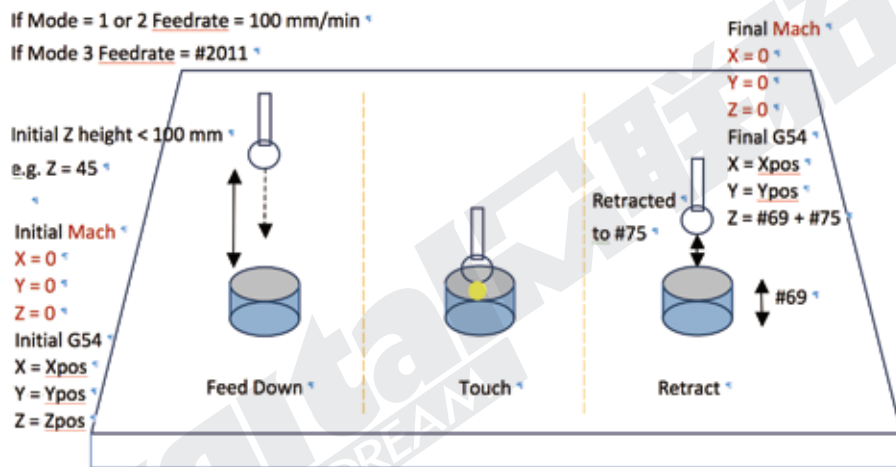


Figure 3-60 Mode 2 Probing Sequence for Z axis when #71 = 0: Current position

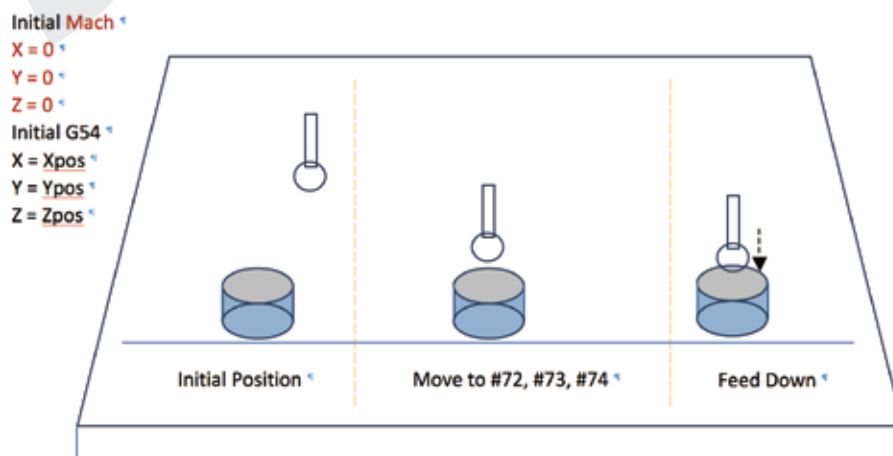


Figure 3-61 Mode 2 Probing Sequence for Z axis when #71 = 1: Fixed position

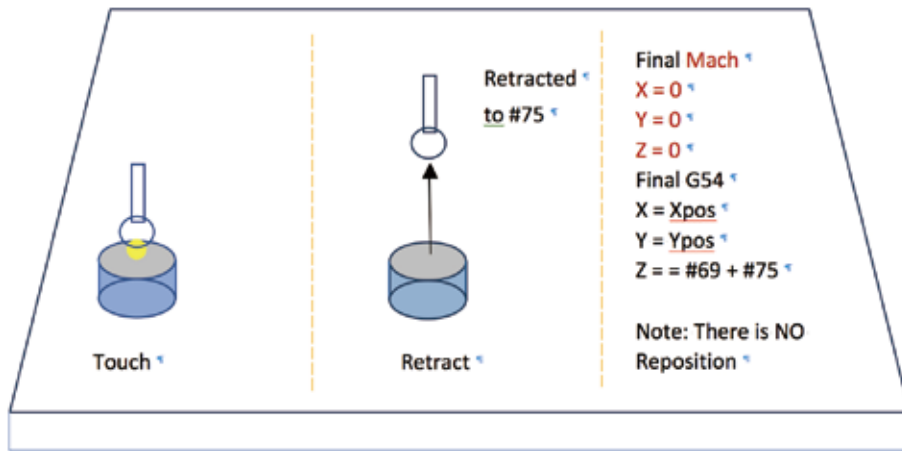


Figure 3-62 Mode 2 Probing Sequence for Z axis #71 = 1:Fixed position

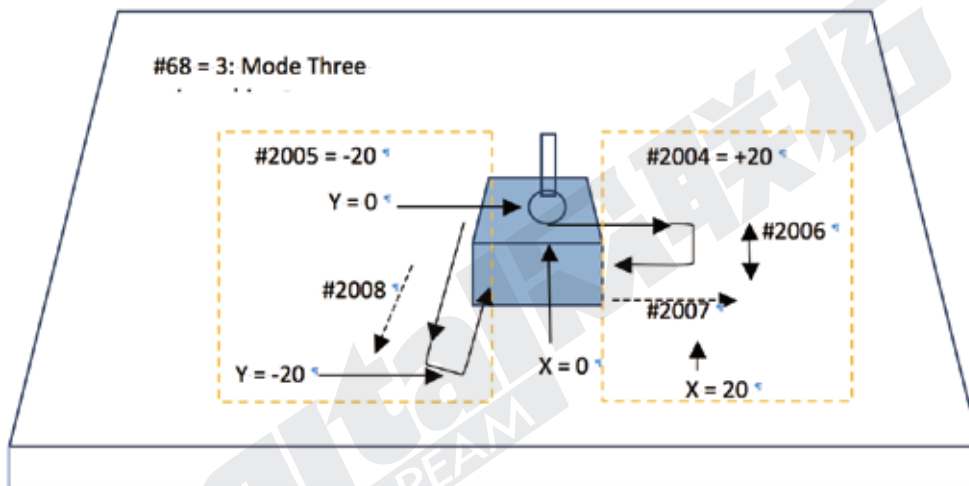


Figure 3-63 Mode 3 Probing Directions

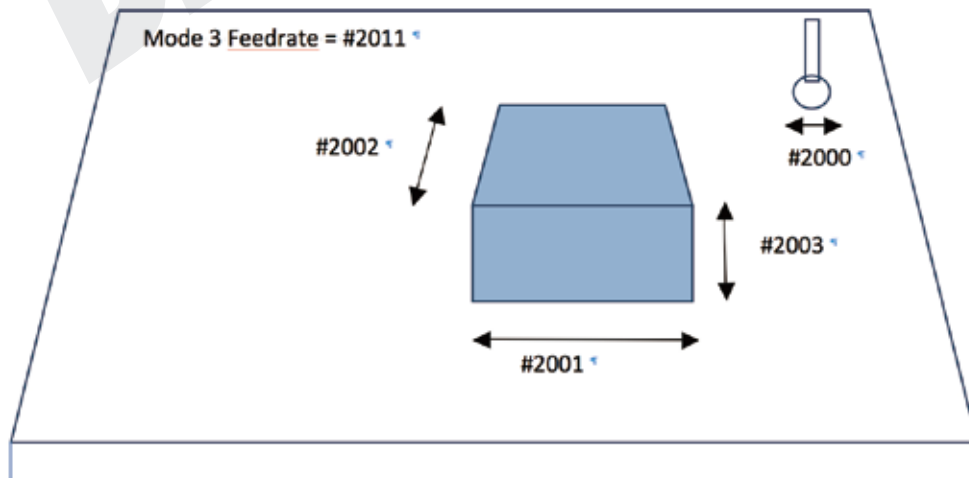


Figure 3-64 Mode 3 Test block parameters

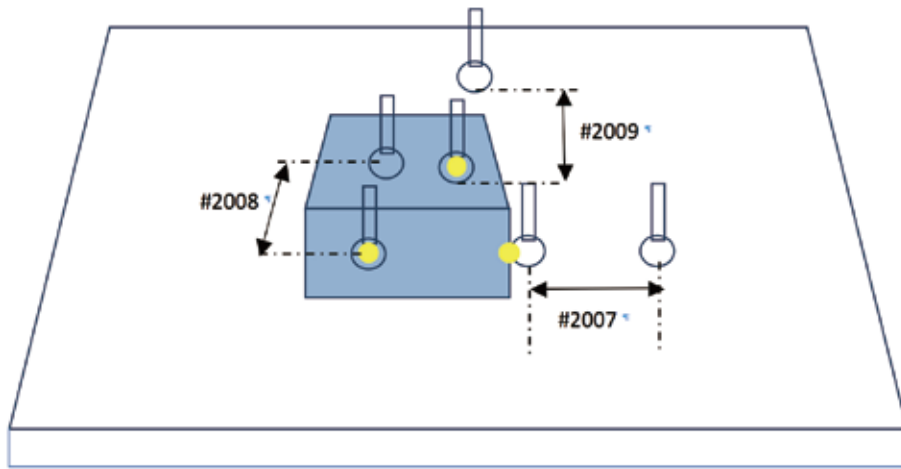


Figure 3-65 Mode 3 Test block retract parameters

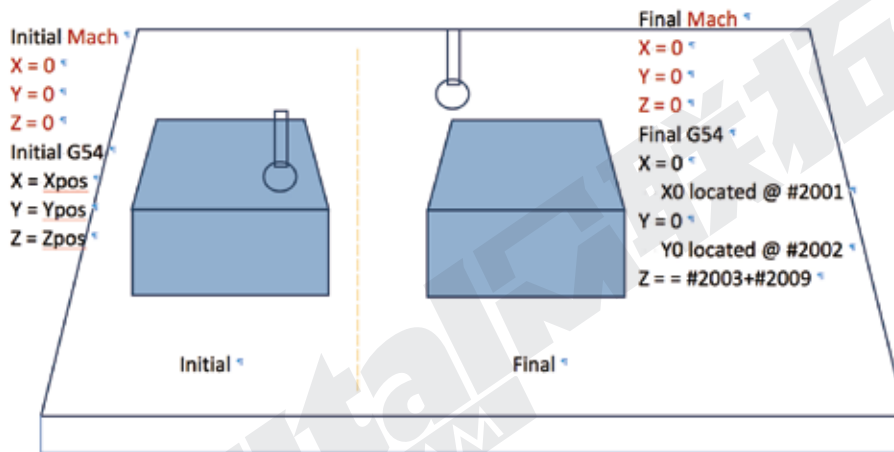


Figure 3-66 Mode 3 Initial and Final Positions

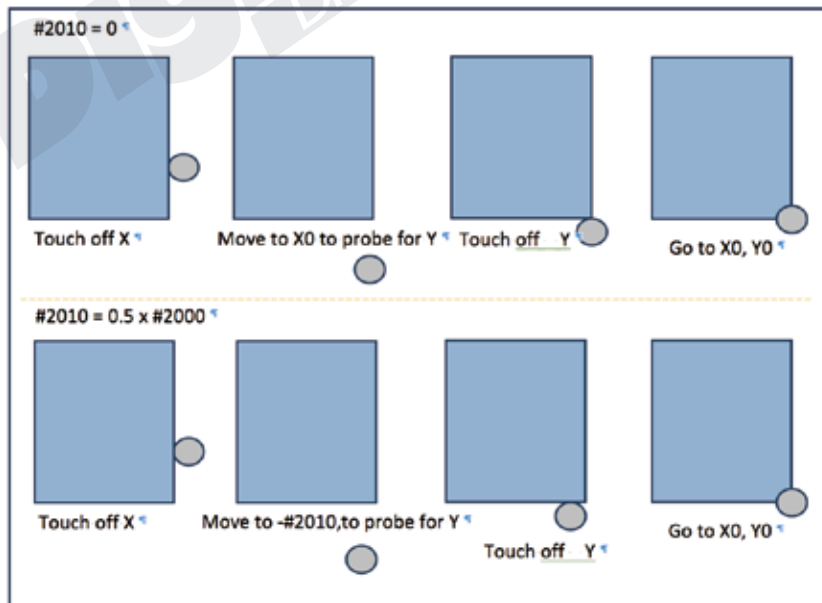



Figure 3-67 Use of #2010 in Mode 3

3.3.5.5 Trial Cutting Function

The ToolPath Key  can also be re-defined as a “TryCutting” function key as defined by Parameter #3, it must be controlled with a connected MPG, this function also can be called as “handwheel guide”.

When the system is READY, press it then start the file, the controller turns into Try Cutting Status, you can use the MPG to operate; When system is AUTO, users press it the controller also turns to Try Cutting status. Press the key again, system exit from Try Cutting.

TRCUT	BUSY	2mmnew.tap	00:00:26
X	-37.912	-37.912 mm	PRO: 100%
Y	-37.952	-37.952 mm	SRO: 100%
Z	5.000	5.000 mm	SJR 0.01
A	0.000	0.000	F 0 99999
3: G0X-49.973Y-50.025Z5.000			S 13999 14000
			G54 M3 M9 M11
			Normal Mod
			Ver:2019-04-25-107NOR
Main Page	File Page	Param Page	DDCSV3.1@DDREAM

Figure 3-68 Try Cutting

3.4 Software Update

According to the customer feedback, we will endeavour to update the software in DDCCS V3.1, to enhance the performance, fix the bugs or add new features. In order for customer to download the latest firmware, please visit our website :

www.ddcnc.com

or our Facebook Forum:

https://www.facebook.com/groups/1724999967517167/?ref=group_header or join our forum <http://bbs.ddcnc.com/forum.php>

There you can find the latest version firmware for DDCCS. At the Left-bottom side of the Main Page, there is the firmware version as the Figure 3-69:

STEP	READY	2mmnew.tap	00:00:17
X	-5.173	-5.173 mm	PRO: 100%
Y	-49.625	-49.625 mm	SRO: 100%
Z	4.140	4.140 mm	SJR 0.01
A	0.000	0.000	F 0 99999
255: X-5.225Z-0.869			S 13999 16000
			G54 M3 M9 M11
			Normal Mod
			Ver:2019-04-25-107NOR
Main Page	File Page	Param Page	DDCSV3.1@DDREAM

Figure 3-69 Firmware Version No.

Download the firmware upgrade file to your computer and prepare a totally empty USB key. Best is to quickly reformat the USB key to MS-DOS FAT32 (right click on the USB key icon and choose Format. Follow the prompts)

After downloading the firmware file check the file name, it may look like this or similar
install(2019-08-16-112)-zip . (example)

This is done to allow the download. Files called “.ZIP” are sometimes blocked.

Change the file name to

install(2019-08-16-112).zip (example)

Now your zip program can recognise the file as a compressed file and you can decompress it to the USB key. Please note the upgraded file should be in the Root-directory in the USB Stick and the file name must be “install”:

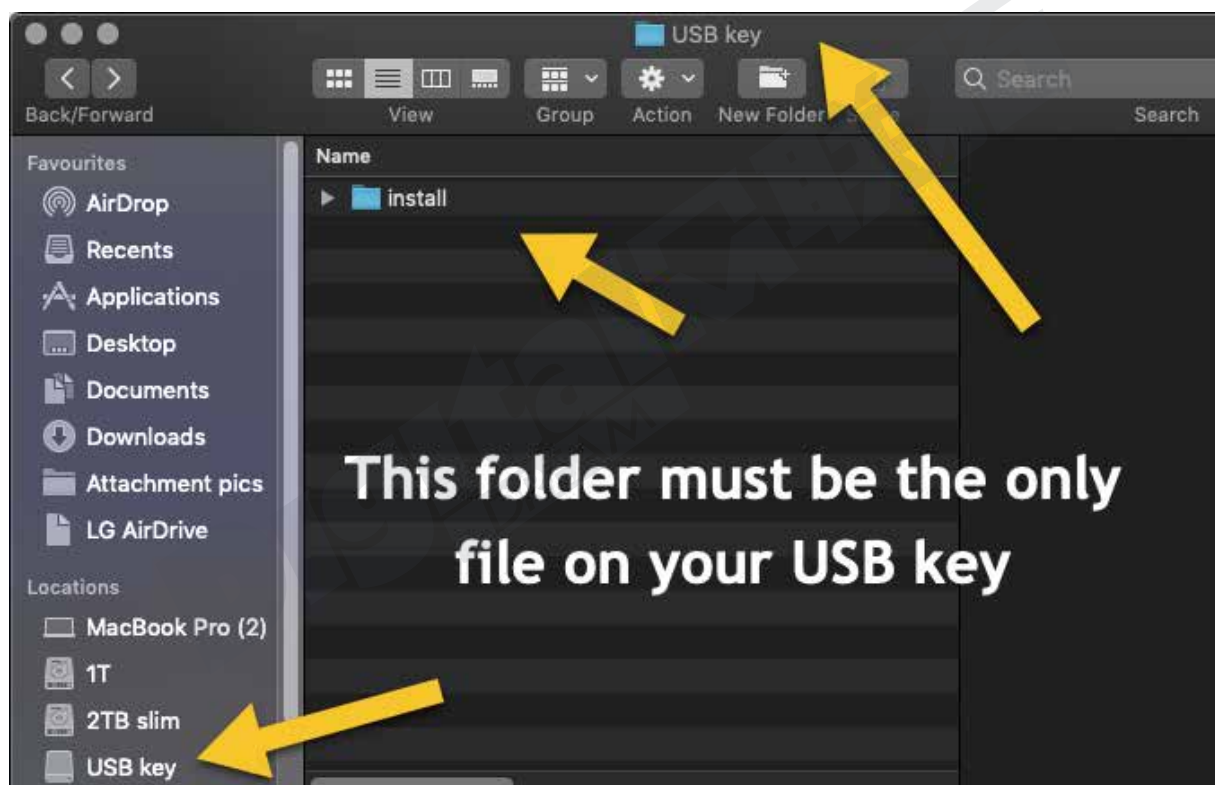


Figure 3-70 Position of firware file

Important:

When upgrading, the entire configuration will be replaced. In most cases however you will want to keep your personal Setting file

Check the content of the INSTALL folder and if you find a file called “setting” delete it.

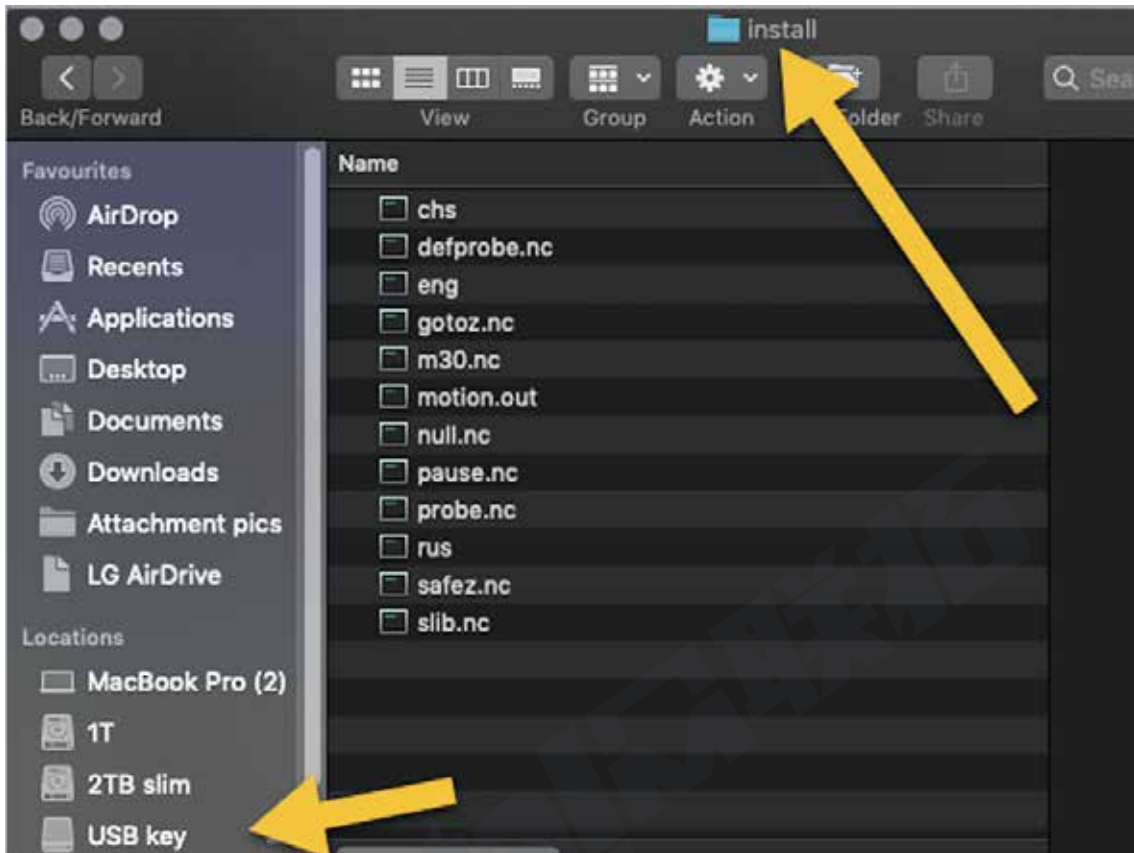


Figure 3-71 The files a INSTALL folder included

Now your zip program can recognise the file as a compressed file and you can decompress it to the USB key. Please note the upgraded file should be in the Root-directory in the USB Stick and the file name must be "install".

Now your USB key is ready for action.

Shut down your DDCCS controller for 10 seconds. Insert the USB key into the USB port of your DDCCS controller .

Start your DDCCS controller. The controller will read the INSTALL folder on the USB key and upgrade automatically. The screen will be blocked for about 30 seconds, then the controller will start with the new firmware.

On the Main Screen lower right you can see the firmware version the controller is using.

After upgrading successfully, don't forget to remove the Intsall folder from the USB key. If you do not remove the INSTALL folder the controller will update again next time you start the controller.

3.5 Keyboard Operation Methods

In the new version of 3.1, in order to supply more convenient operation options for customers, the users not only can use the controller Panel to operate, but also can use the keyboard and MPG. Here we describe the operation methods by keyboard.

Important: Please select the keyboard with USB connection, and with numerical pad. The following Figure is for your references:

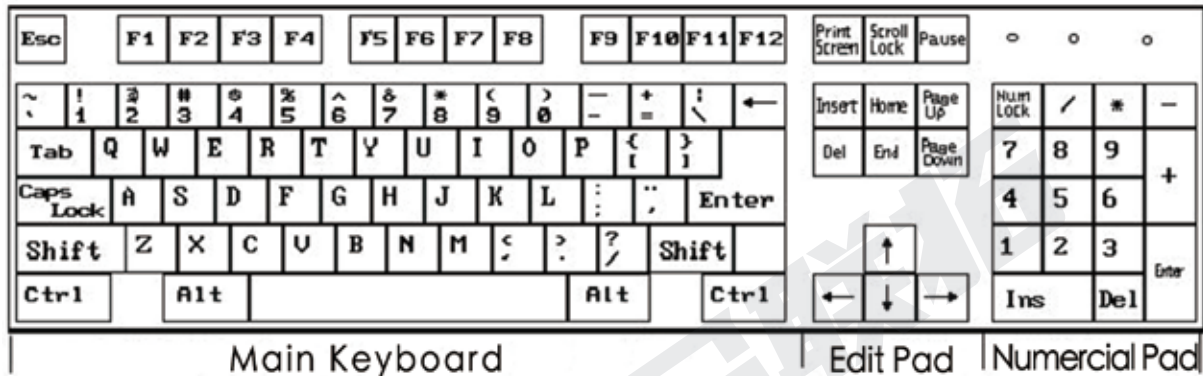


Figure 3-72 The USB Keyboard

Function	Keys on Keyboard	Operation Methods
X-	1: LEFT ARROW(←) 2: Numeric keypad '4'	1: X Axis Moves to Left Side; 2: Cursor Moves Left;
X+	1: RIGHT ARROW(→) 2: Numeric keypad '6'	1: X Axis Move to right Side; 2: Cursor Move right;
Y-	1: DOWN ARROW(↓) 2: Numeric keypad '2'	1: Y Axis moves to back side; 2: Decrease the numbers;
Y+	1: UP ARROW(↑) 2: Numeric keypad '8'	1: Y axis moves to forward side; 2: Increase the numbers;
Z-	1: PAGEDOWN 2: Numeric keypad '3'	1: Z Axis moves down; 2: In File and Param page moves down the selection;
Z+	1: PAGEUP 2: Numeric keypad '9'	1: Z Axis moves up; 2: In File and Param page moves Up the selection;
A-	Numeric keypad '1'	1: Decrease at A Axis
A+	Numeric keypad '7'	1: Increase at A Axis
Centering operation	F3	Used in conjunction with the MPG axis selection. Only when the MPG axis is selected as X or Y, the corresponding axis performs the centering operation

Function	Keys on Keyboard	Operation Methods
Goto Zero	1: F5 2: Numeric keypad '0'	Used in conjunction with the MPG axis selection. If the MPG axis is selected to be empty, the whole axis will goto zero. If the MPG axis is selected as X, the X axis will goto zero.
Zero	1: F6 2: Numeric keypad 'DEL'	Used in conjunction with the MPG axis selection.If the MPG axis is selected to be empty, the whole axis will be zero. If the MPG axis is selected as X, the X axis will be zero.)
Home	F7	The first press enters the HOME mode. In the HOME mode, press again to perform full axis HOME, or press the corresponding axis selection key, the corresponding axis perform HOME separately: HOME X-axis selection:'X' HOME Y-axis selection:'Y' HOME Z-axis selection:'Z' HOME A-axis selection:'A'
PROBE	F8	The first press enters PROBE mode and presses again to perform the PROBE operation
Manual mode switching	1: F10 2: Numeric keypad '*'	Same function of "Mode" in controller panel, shift among "CONT" 、 "STEP" 、 "MPG"
Jog distance adjustment	Numeric keypad "5"	#2020, #2021, #2022, #2023 can define the Jog distance. The Key is to shift among the 4 distance.
FRO adjustment	1: Main keyboard "F" 2: Main Keyboard "8"	Can define the F value as the current feeding speed,or cancel F value as the current speed (current speed set by G-code file)
SRO adjustment	1: Main Keyboard "S" 2: Main Keyboard "9"	Can define the S value as the current feeding speed,or cancel S value as the current speed (current speed set by G-code file)
Coordinate system Selection	1: Main Keyboard "G" 2: Main Keyboard "0"	Start a G-code file processing
START	1: SCROLL LOCK 2: Numeric keypad '-'	Pause a processing job.
PAUSE	1: PAUSE BREAK 2: Numeric keypad '+'	Shift among the coordinate system.
TRY CUT:	1: F11 2: Numeric keypad "ENTER"	When controller in Auto mode,Press it will enter into Try Cut mode,need to work with MPG.
Single-Stage processing mode	F4	The single-segment mode can be switched while the system is idle. After starting the machining in single-segment mode, the system executes one line each time the start button is pressed.
Focus TAB	1: F9 2: Numeric keypad '/'	Same function of "Shift" on Controller Panel.
Focus adjustment+	Main Keyboard "+"	Increase Numbers in controller system;
Focus adjustment-	Main Keyboard "-"	decrease Numbers in controller system;
Page switching	1: TAB 2: BACKSPACE	Same funciton as "Page" on controller Panel.
ToolPath display	F12	Display or cancel the ToolPath.
Uninstall U disk	Main keyboard 'DELETE'	Popup USB-Stick from Controller system.

4 Parameter Instruction

4.1 The detailed definition of parameters

1) Top Parameters (Totally 3 items)

Para. Mark	Parameter definition	Default value	Parameter Unit	Parameter Scope	Notes
#5	minimum log radius of 4 axis machining	5	mm	3-999.999	
#6	A axis rotate reference axis	3		0-3	0=X axis,1=Y axis, 2=Z axis,3=not rotate
#104	A axis optimal path when G0 run	0		1/0	0=No,1=Yes

#5: If your controller is 4 axes with A axis, the A axis will rotate in the speed of F (recombination Speed). But when the radius is an unlimited small value, the A axis rotating speed will be unlimited-high, that will cause problems. In the situation, we set the min radius is 3, to avoid the situation.

#6: This value optimizes algorithm of A axis. Depend on the selection, we can project the rotating arc line on to X or Y or Z axis with F value. If select "not rotate", this algorithm is not active.

2) Motor Parameters (Totally 16 items)

Para. Mark	Parameter definition	Default value	Parameter Unit	Parameter Scope	Notes
#33	Motor start speed	50	mm/min	0-999	Motor Speed of first step
#34	X axis pulse equivalency	2560	pulse/mm	50-99999.000	The Pulses needed for feeding 1mm
#35	Y axis pulse equivalency	2560	pulse/mm	50-99999.000	
#36	Z axis pulse equivalency	2560	pulse/mm	50-99999.000	
#38	A axis pulse equivalency	640	pulse/mm	50-99999.000	
#39	A axis pulse unit	0	BOOL	1/0	0=pulse/deg, 1=pulse/circle
#40	AB axis Selection	0	BOOL	1/0	0=A axis, 1=B axis
#390	X axis DIR signal Electric Level	0	BOOL	1/0	1=high, 0=low
#391	Y axis DIR signal Electric Level	1	BOOL	1/0	
#392	Z axis DIR signal Electric Level	1	BOOL	1/0	
#393	A axis DIR signal Electric Level	0	BOOL	1/0	
#416	Time interval between DIR & PUL	7000	ns	0-9999.000	Direction is ahead of Pulse
#418	X axis Pulse signal Electric Level	0	BOOL	1/0	1=high, 0=low
#419	Y axis Pulse signal Electric Level	0	BOOL	1/0	
#420	Z axis Pulse signal Electric Level	0	BOOL	1/0	
#421	A axis Pulse signal Electric Level	0	BOOL	1/0	

#416: After years experience and debugging, 7000 is a suitable value for stepper system.

3) Manual Control Parameters(Totally 20 items)

Para. Mark	Parameter definition	Default value	Parameter Unit	Parameter Scope	Notes
#41	X Axis max speed in M_Ctrl mode	16000	mm/min	99-99999	Limits the speed if using FRO to change the speed
#42	Y Axis max speed in M_Ctrl mode	16000	mm/min	99-99999	
#43	Z Axis max speed in M_Ctrl mode	16000	mm/min	99-99999	
#44	A Axis max speed in M_Ctrl mode	16000	deg/min	99-99999	
#45	X axis start Acc in M_Ctrl mode	9	mm/s ²	1-9999	X,Y,Z,A axis Initial Acceleration Speed in Manual control mode.
#46	Y axis start Acc in M_Ctrl mode	300	mm/s ²	1-9999	
#47	Z axis start Acc in M_Ctrl mode	300	mm/s ²	1-9999	
#48	A axis start Acc in M_Ctrl mode	300	deg/s ²	1-9999	
#100	X axis manual control speed	3000	mm/min	99-99999	X,Y,Z,A axis Feed Speed in Manual control mode.
#101	Y axis manual control speed	3000	mm/min	99-99999	
#102	Z axis manual control speed	2000	mm/min	99-99999	
#103	A axis manual control speed	12000	deg/min	99-99999	
#263	X axis stop Acc in M_Ctrl mode	600	mm/s ²	9-9999	X,Y,Z,A axis Deceleration in Manual control mode.
#264	Y axis stop Acc in M_Ctrl mode	600	mm/s ²	9-9999	
#265	Z axis stop Acc in M_Ctrl mode	600	mm/s ²	9-9999	
#266	A axis stop Acc in M_Ctrl mode	600	deg/s ²	9-9999	
#2020	Jog-1 moving distance	0.010	mm	0-999	4 kinds Jog Moving distance
#2021	Jog-2 moving distance	0.100	mm	0-999	
#2022	Jog-3 moving distance	1.000	mm	0-999	
#2023	Jog-4 moving distance	10.000	mm	0-999	

A) The FRO override range is 0~300%, However the real feed speed may be too high for the machine, so we use #41-44 to set a limited speed for safety reason.

B) Please note that the Max. speed cannot be set as Manual control speed. In the controller system we designed the algorithm for the speed palm based on the manual control speed, if the max. speed is smaller than manual control speed, will disturb the algorithm plan.

C) DDCS V3.1 supports Asymmetric Acc/Dec speed. But when the MPG is in control mode (Precision control mode), the controller will execute each pulse the MPG made, in this situation controller don't support Asymmetric Acc/Dec speed, when stop the system also use the Start Acc Speed.

D) In the mode of STEP, actual Start&Stop Acc/Dec speed both are start acc speed.

4) Automatic Control Parameters (Totally 16 Items)

Para. Mark	Parameter definition	Default value	Parameter Unit	Parameter Scope	Notes
#15	Speed Selection	1	BOOL	1/0	0: G code; 1:default
#76	default operation speed	3000	mm/min	10~99999	
#77	maximum speed	12000	mm/min	99~99999	The Max. feeding speed
#78	Z axis lifting protection speed	3000	mm/min	99~99999	Limited speed only for Z axis
#79	Z axis dropping protection speed	3000	mm/min	99~99999	
#80	G0 Speed	3000	mm/min	99~99999	G0 Feeding Speed
#82	Z axis safe height	5	mm	0~99	When finish the job Z moves to safety height
#89	Z axis back distance when pause	5	mm	0~99	cannot be negative value
#99	operation acceleration	300	mm/min ²	9~9999	It is recombination Acc Speed
#113	Arc interpolation algorithm selection	0	BOOL	1/0	0: Hard algorithm ; 1: Soft algorithm
#124	Circular centrifugal acceleration	0.000	mm/min ²	0~9999	It is Recombination Acc Speed
#125	Circular speed adjustment factor	0.100	mm/min ²	0.1~2.0	Circular Speed=F*#125
#435	X axis protection speed	99999	mm/min	99~99999	Protection Speed at X axis, protection by soft algorithmX
#436	Y axis protection speed	99999	mm/min	99~99999	Protection Speed at Y axis, protection by soft algorithmX
#2031	Uniaxial acc is limited by M_Ctrl start acc	0	1/0	1=yes, 0=no	Uniaxial acc speed protection
#2037	Is FRO valid for G0?"	0	1/0	1=yes, 0=no	

A) #77: In the Automatic control mode, the FRO is still can determine the feeding speed (Up to 300%), in order to avoid bad situation, we set a limited speed here.

B) #113: In DDCS System, there is soft algorithm and hard algorithm, hard algorithm is processed by FPGA logic, the movement is very smooth, and high precise; Soft algorithm is to cut the arc line to a lot of little small pieces. But only when the pulse equivalents of several axis which join into doing the circular interpolation are the same, the hard algorithm can work well; and soft algorithm has no request for pulse equivalents. So when the controller work for helix interpolation, it is better to use soft algorithm.

C) #124: When the rotating diameter is too small, better to limit the speed, by which to avoid the rotation speed is too high because of too small diameter.

D) #125: When we process a G-code file, only F value to control the feeding speed. But for circular arc movement is very different situation and need to set a more suitable speed for it. Then we can use this parameter: circular arc speed = F * #125

E) #435 & #436: In Auto Mode, the feed speed is set by F value. System will calculate out a projection speed on X and Y separately by F value. The control system will cite a slower speed between the protection speed and projection speed on X or Y.

F) #2031: In Auto Mode, the acc speed only can be controlled by one parameter that is #99. But there are 4 axes each one is in different mechanical situation. #2031 parameter brings the "start Acc in M_Ctrl mode" (#45, #46, #47, #48) to Auto Mode. For example, if #2031=1, and "X axis start Acc in M_Ctrl" is lower than the projection Acc speed on X axis from #99, system will cite the "X axis start Acc in M_Ctrl mode" in Auto mode processing.

5) Coordinate System Parameters (1 Item)

Para. Mark	Parameter definition	Default value	Parameter Unit	Parameter Scope	Notes
#16	current coordinate system	1	BOOL	0-6	0-5: G54-G59, 6: Mach

6) Spindle Parameters (Totally 9 Items)

Para. Mark	Parameter definition	Default value	Param Unit	Param Scope	Notes
#98	maximum spindle speed	24000	rpm	99-99999	Spindle PWM or voltage signal full range is corresponding to speed
#219	If Stop Spindle when pause	0	BOOL	1/0	0=No, 1=Yes
#220	Spindle speed selection	0	BOOL	1/0	0:by G code,1:default speed
#221	default spindle speed	5777	rpm	10-99999	can be defined
#222	Spindle commands M3/M5 response	1	BOOL	1/0	0:not response,1:response
#224	Spindle M3/M4/M5 response Duration	3	s	0-9	
#227	Spindle switch Active level	1	BOOL	1/0	0=Low, 1=High
#422	definition of PWM Electric level	0	BOOL	1/0	0=Low, 1=High
#433	PWM rising rate from 0V to 10V	0	BOOL	0-65535	The acceleration time to full speed is #433*0.0005s

A) #220:When we set it as “1”,select the default speed,even when there is no Start Command on G-code file,when you start the machine spindle will also start;

B) #422:DDCS supports PWM but need to remove a capacitor.The more detailed information please contact us at info@ddcnc.com.

7) Output Signal Parameters (Totally 8 items)

Para. Mark	Parameter definition	Default value	Param Unit	Param Scope	Notes
#108	M Bus IO command response	0	BOOL	1/0	0=No response; 1=response
#109	M Bus IO default status	0	BOOL	0-4294967295	
#110	M Bus IO Initialization strategy	0	BOOL	1/0	0=Mode 1; 1=Mode 2
#223	response of M code(M8/M9,M10/M11)	1	BOOL	1/0	0=No response; 1=response
#225	delay time of M8/M9	1	S	0-9	
#226	delay time of M10/M11	1	S	0-9	
#228	M8/M9 active electric level	1	BOOL	1/0	0=Low, 1=High
#229	M10/M11 active electric level	1	BOOL	1/0	0=Low, 1=High

8) Home Parameters (Totally 32 Items)

Para. Mark	Parameter definition	Default value	Param Unit	Param Scope	Notes
#49	HOME times	1	BOOL	1-5	
#50	HOME signal Effective when HOME	0	BOOL	1/0	0: Ignore HOME; 1: Continue HOME
#51	Enable limit signal when HOME	0	BOOL	1/0	1:Disable; 0: Enable
#52	Enable X Home Searching function	1	BOOL	1/0	0: Disable; 1: Enable
#53	Enable Y Home Searching function	1	BOOL	1/0	
#54	Enable Z Home Searching function	1	BOOL	1/0	
#55	Enable A Home Searching function	1	BOOL	1/0	
#56	X axis Home speed	1600	mm/s	99~99999	Signal Axis Homing Speed
#57	Y axis Home speed	1600	mm/s	99~99999	
#58	Z axis Home speed	1600	mm/s	99~99999	
#59	A axis Home speed	800	mm/s	99~99999	
#60	X axis Home signal Electric Level	0	BOOL	1/0	0=Low, 1=High
#61	Y axis Home signal Electric Level	0	BOOL	1/0	
#62	Z axis Home signal Electric Level	0	BOOL	1/0	
#63	Z axis Home signal Electric Level	0	BOOL	1/0	
#64	X axis Home direction	0	BOOL	1/0	0: Reverse direction home (--) 1: Forward direction home (++)
#65	Y axis Home direction	0	BOOL	1/0	
#66	Z axis Home direction	0	BOOL	1/0	
#67	A axis Home direction	0	BOOL	1/0	
#83	X axis back distance after Home	10	mm	0~99	After homing, each axis needs to move away from the home switch for a certain distance. The parameter of this group is this back off distance.
#84	Y axis back distance after Home	10	mm	0~99	
#85	Z axis back distance after Home	10	mm	0~99	
#86	A axis back distance after Home	0	deg	0~360	
#116	X-axis zero signal source select	0	mm	0~99	0: HOME signal; 1: Forward Direction limit signal; 2: Reverse Direction limit signal.
#117	Y-axis zero signal source select	0	mm	0~99	
#118	Z-axis zero signal source select	0	mm	0~99	
#119	A-axis zero signal source select	0	mm	0~2	
#126	Home reminder after booting	0	BOOL	0/1	0:No; 1:Yes
#2024	X axis Home offset	0	mm	-999~999	After finishing Homing,the new position can be set as a value(offset) in the coordinate system.
#2025	Y axis Home offset	0	mm	-999~999	
#2026	Z axis Home offset	0	mm	-999~999	
#2027	A axis Home offset	0	deg	-999~999	

A) #51: When the Limit signal and Homing signal share one switch, while Homing need to disable the Limit signal.

B) #60~#63, #64~#67: When the Limit signal and Homing signal share one switch, these two parameter groups are not used.

9) Probe Parameter (Totally 20 items)

Para. Mark	Parameter definition	Default value	Param Unit	Param Scope	Notes
#68	Tool Setting function mode	0	BOOL	1/0	0: Disable; 1: mode 1; 2: mode 2; 3: mode 3
#69	Thickness of tool sensor	1	mm	0-200	
#70	Probe signal electric level	0	BOOL	1/0	0=Low, 1=High
#71	Initial tool's position	0	BOOL	1/0	0: current position; 1: fixed position
#72	Initial probe position on X axis	0	mm	-9999-9999	Initial Position of the probe sensor in Mach Coordinate
#73	Initial probe position on Y axis	0	mm	-9999-9999	
#74	Initial probe position on Z axis	0	mm	-9999-9999	
#75	back distance after probe	5	mm	-9999-9999	
#2000	Cutter diameter	6	mm	0-999	Cutter/probe sensor diameter
#2001	Tool plate thick for X	0	mm	0-999	The thickness of the block which used as Probe Plate.
#2002	Tool plate thick for Y	0	mm	0-999	
#2003	Tool plate thick for Z	0	mm	-999-999	
#2004	shift of X axis before probed	20	mm	-999-999	This parameter group is used for next probe move
#2005	shift of Y axis before probed	-20	mm	-999-999	
#2006	Z position before X(Y)-axis probed	-5	mm	-999-999	
#2007	Back distance when the tool touches the X-axis edge	1	mm	0-999	
#2008	Back distance when the tool touches the Y-axis edge	1	mm	0-999	
#2009	Back distance when the tool touches the Z-axis edge	1	mm	0-999	
#2010	center of tool plate	9	mm	0-999	
#2011	Probe feedrate	20	mm/min	10-999	

A) #68: 0: disable ;1: Probe of Fix Position Tool Sensor; 2: Probe of Floating Tool Sensor; 3: Probe of Rectangular Block.

B) #2004 .. 2006: This group parameters define the position before probe of each axis. See section 3.3.5.4 for full information.

10) Hard Limit Parameters (Totally 16 items)

Para. Mark	Parameter definition	Default value	Param Unit	Param Scope	Notes
#400	Limited signal active of X--	1	BOOL	1/0	0: Disable; 1: Enable
#401	Limited signal active of Y--	1	BOOL	1/0	0: Disable; 1: Enable
#402	Limited signal active of Z--	1	BOOL	1/0	0: Disable; 1: Enable
#403	Limited signal active of A--	1	BOOL	1/0	0: Disable; 1: Enable
#404	Limited signal active of X++	1	BOOL	1/0	0: Disable; 1: Enable
#405	Limited signal active of Y++	1	BOOL	1/0	0: Disable; 1: Enable
#406	Limited signal active of Z++	1	BOOL	1/0	0: Disable; 1: Enable
#407	Limited signal active of A++	1	BOOL	1/0	0: Disable; 1: Enable
#408	Effective electric level of X--	0	BOOL	1/0	0=Low; 1=High
#409	Effective electric level of Y--	0	BOOL	1/0	0=Low; 1=High
#410	Effective electric level of Z--	0	BOOL	1/0	0=Low; 1=High
#411	Effective electric level of A--	0	BOOL	1/0	0=Low; 1=High
#412	Effective electric level of X++	0	BOOL	1/0	0=Low; 1=High
#413	Effective electric level of Y++	0	BOOL	1/0	0=Low; 1=High
#414	Effective electric level of Z++	0	BOOL	1/0	0=Low; 1=High
#415	Effective electric level of A++	0	BOOL	1/0	0=Low; 1=High

11) Software limit Parameters (Totally 9 items)

Para. Mark	Parameter definition	Default value	Param Unit	Param Scope	Notes
#374	Enable software limit	0	BOOL	1/0	0: Disable; 1: Enable
#375	Soft-limited postion value of X--	100	mm	-9999-9999	The group Parameter will trigger the limit signal of negative direction. The limit values refer to the machine coordinates, not the work piece coordinate.
#376	Soft-limited postion value of Y--	-400	mm	-9999-9999	
#377	Soft-limited postion value of Z--	-20	mm	-9999-9999	
#378	Soft-limited postion value of A--	0	deg	-9999-9999	
#379	Soft-limited postion value of X++	100	mm	-9999-9999	The group Parameter will trigger the limit signal of Positive direction. The limit values refer to the machine coordinates, not the work piece coordinate.
#380	Soft-limited postion value of Y++	400	mm	-9999-9999	
#381	Soft-limited postion value of Z++	20	mm	-9999-9999	
#382	Soft-limited postion value of A++	0	deg	-9999-9999	
#2030	Soft-limited stop mode	0			0: deceleration; 1: emergency
#2032	Soft-limited pre-judgment coefficient of X	1.000		0.5~2.0	When triggered the soft limit,in order to control the stop speed,we set this group parameters.
#2033	Soft-limited pre-judgment coefficient of Y	1.000		0.5~2.0	
#2034	Soft-limited pre-judgment coefficient of Z	1.000		0.5~2.0	
#2035	Soft-limited pre-judgment coefficient of A	1.000		0.5~2.0	

#347: #347 is Enable/disable soft-limit function for All Axes.If the users need to disable only one axis,he can set the soft-limit negative value bigger than the positive value,that will make this axis soft-limit invalid.

12) MPG Parameters (Totally 8 Items)

Para. Mark	Parameter definition	Default value	Param Scope	Notes
#428	Enable the ESTOP signal on MPG	1	1/0	0: Disable,1: Enable
#429	Electric level of ESTOP on MPG	0	1/0	0=Low; 1=High
#430	MPG interface type	1	1/0	0: Seria; 1: Standard
#431	MPG Precision	0.004	0.001~0.01	This value is bigger,each step of the handwheel is bigger
#432	Standard MPG signal Electric Level	1	1/0	0=Low; 1=High
#434	A/B phase signal level on MPG	0	1/0	0=Low; 1=High
#448	MPG control mode	0	1/0	0=Open; 1=Close
#2028	The % of the change in value per X Pulses of the Handwheel	10	1~100	The change rate of FRO&SRO by MPG, the value is higer,the change is slower.

#448: The user can turn the MPG wheel faster that the controller can move the table. If #448 = 0 the system will store the pulses so that when the user stops turning the wheel the machine axis will still move. This can lead to a crash. If #448 = 1 when the user stops turning the wheel the system will immediately decelerate and stop

#2028: The FRO and SRO rate also can be changed by MPG.When the value is higer the changing rate is slower.

13) External Button Parameters (Totally 7 items)

Para. Mark	Parameter definition	Default value	Param Scope	Notes
#423	Enable signal of extended ESTOP	1	1/0	0=Disable 1; 1=Enable
#424	Electric level of ext-ESTOP signal	0	1/0	0=Low, 1=High
#425	Enable extended START&PAUSE	1	1/0	0=Disable 1; 1=Enable
#426	Electric level of Ext-key1	0	1/0	0=Low, 1=High
#427	Electric level of Ext-key2	0	1/0	0=Low, 1=High
#446	Define the Function of Ext-key1	0	0~3	0: START; 1: Find Middle; 2: "extkey1.nc" ; 3: JOG-D
#447	Define the Function of Ext-key2	0	0~3	0: PAUSE; 1: ZERO; 2: "extkey2.nc" ; 3: S/P ctrl

A) #446:0: Starts the machine;

1: Find the middle, need to work with MPG, the function is same as F3 of the Keyboard;

2: Runs the code contained in the file extkey1.nc ;

3: Shift between 4 kinds JOG distances(#2020,#2021,#2022,#2023).

B) #447:0: Pauses the machine ;

1: Zero all axes in current coordinate system ;

2: Runs the code contained in the file extkey2.nc ;

3: Start/Pause Key. Note: The function only can work when processing the G-code file .

14) Backlash Parameters (Totally 8 Items)

Para. Mark	Parameter definition	Default value	Param Unit	Param Scope	Notes
#437	Enable of X axis backlash	0	BOOL	1/0	0:Disable, 1:Enable
#438	Enable of Y axis backlash	0	BOOL	1/0	
#439	Enable of Z axis backlash	0	BOOL	1/0	
#440	Enable of A axis backlash	0	BOOL	1/0	
#441	X axis backlash distance	0	mm	0~0.999	Set the backlash return as you need for each axis. Tip: experiment with the settings and check the results
#442	Y axis backlash distance	0	mm	0~0.999	
#443	Z axis backlash distance	0	mm	0~0.999	
#444	A axis backlash distance	0	deg	0~9.999	

15) Tool Offset (Totally 32 Items)

Para. Mark	Parameter definition	Default value	Param Unit	Param Scope	Notes
#267	H00 Tool Offset	0.000	BOOL	-999.999 ~ 999.999	This H group is for Tool Length Compensation
#268	H01 Tool Offset	0.000	BOOL	-999.999 ~ 999.999	
#269	H02 Tool Offset	0.000	BOOL	-999.999 ~ 999.999	
#270	H03 Tool Offset	0.000	BOOL	-999.999 ~ 999.999	
#271	H04 Tool Offset	0.000	BOOL	-999.999 ~ 999.999	
#272	H05 Tool Offset	0.000	BOOL	-999.999 ~ 999.999	
#273	H06 Tool Offset	0.000	BOOL	-999.999 ~ 999.999	
#274	H07 Tool Offset	0.000	BOOL	-999.999 ~ 999.999	
#275	H08 Tool Offset	0.000	BOOL	-999.999 ~ 999.999	
#276	H09 Tool Offset	0.000	BOOL	-999.999 ~ 999.999	
#277	H10 Tool Offset	0.000	BOOL	-999.999 ~ 999.999	
#278	H11 Tool Offset	0.000	BOOL	-999.999 ~ 999.999	
#279	H12 Tool Offset	0.000	BOOL	-999.999 ~ 999.999	
#280	H13 Tool Offset	0.000	BOOL	-999.999 ~ 999.999	
#281	H14 Tool Offset	0.000	BOOL	-999.999 ~ 999.999	
#282	H15 Tool Offset	0.000	BOOL	-999.999 ~ 999.999	

Para. Mark	Parameter definition	Default value	Param Unit	Param Scope	Notes
#283	D00 Tool Offset	0.000	BOOL	-999.999 ~ 999.999	This D group is for Tool Radius Compensation
#284	D01 Tool Offset	0.000	BOOL	-999.999 ~ 999.999	
#285	D02 Tool Offset	0.000	BOOL	-999.999 ~ 999.999	
#286	D03 Tool Offset	0.000	BOOL	-999.999 ~ 999.999	
#287	D04 Tool Offset	0.000	BOOL	-999.999 ~ 999.999	
#288	D05 Tool Offset	0.000	BOOL	-999.999 ~ 999.999	
#289	D06 Tool Offset	0.000	BOOL	-999.999 ~ 999.999	
#290	D07 Tool Offset	0.000	BOOL	-999.999 ~ 999.999	
#291	D08 Tool Offset	0.000	BOOL	-999.999 ~ 999.999	
#292	D09 Tool Offset	0.000	BOOL	-999.999 ~ 999.999	
#293	D10 Tool Offset	0.000	BOOL	-999.999 ~ 999.999	
#294	D11 Tool Offset	0.000	BOOL	-999.999 ~ 999.999	
#295	D12 Tool Offset	0.000	BOOL	-999.999 ~ 999.999	
#296	D13 Tool Offset	0.000	BOOL	-999.999 ~ 999.999	
#297	D14 Tool Offset	0.000	BOOL	-999.999 ~ 999.999	
#297	D15 Tool Offset	0.000	BOOL	-999.999 ~ 999.999	

16) System Setting (Totally 12 Items)

Para. Mark	Parameter definition	Default value	Default Unit	Param Scope	Notes
#1	Language setting	1	BOOL	0-2	0: Eng; 1: 中国; 2: Русский
#2	Display response during working	4000	BOOL	400-10000	If just normal size the value 400 is ok;but if very tiny lines with big file set the value is 4000.
#3	Function of tool path key	0	BOOL	0/1	0: tool path; 1: Try cutting
#88	Enable of beep	1	BOOL	0/1	0: Disable; 1:Enable
#114	Jog support in continuous mode	2	BOOL	0/1	0: Mode 1; 1: Disable; 2: Mode 2
#115	Coordinate unit selection	0	BOOL	0/1	0: mm; 1: inch
#218	Cycle Start key mode selection	0	BOOL	0/1	0: Pause start; 1: Restart
#238	IO input filter time width	10	ms	0.001-9999.999	
#250	Real track paint enable	1	s	0/1	0: disable; 1: enable
#253	Track paint mode	0	BOOL	1/0	0: Statue Mode; 1: Line Mode
#495	Interpolation period	0.005	s	0.002-0.010	
#2029	color reversal	0	BOOL	0/1	0: No; 1: Yes

A) #2: Display response during working. This time is for analysing the file. When the file size is big, just set a higher time value, and also don't display the toolpath, save the time and memory for the file analysing;

#250 is for the same reason. If file too big, set it to "disable".

B) #115: No matter in Metric Units or Imperial Units, the pulse equivalent is based on Metric Unit, so F value is always based on Metric Unit (mm);

C) #238: IO input filter time width. It for the external E-stop signal, Homing signal, limited signal and MPG reset signal, to avoid the noise and interference, set a filter time width;

D) #253: Mode of draw tool road: As for the plane line, such as the PCB engraving or the color plates lettering, please adopt the line pattern. As for the plane embossment, please adopt the statue pattern.

E) #495: The value is smaller, the processing will be more smoothly, but longer working time; The value is bigger, the working time is shorter, but if the time is too short that will a hit for machine.

4.2 Save the Parameters Setting

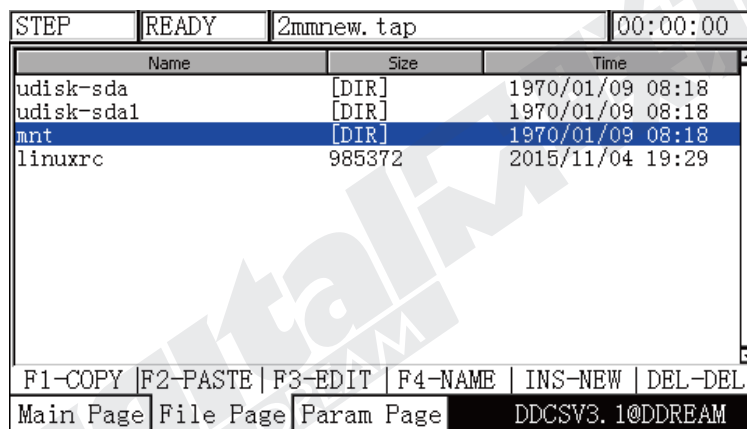
When the Users wants to save the newly defined parameters, or wants to copy the same settings to another DDCS V3.1 controller, this how to do it:

For more information on file management refer to section 3.3.1

Power on the controller, wait for it to boot up, insert the USB memory stick.

Press the Page button and go to the File Page.

Locate the folder named “mnt”, [this is the system folder]. In this folder, there is a folder named “nand1-1”, this folder contains all the system files. In here there is a file named “setting”, select it and press copy it using the TAB key

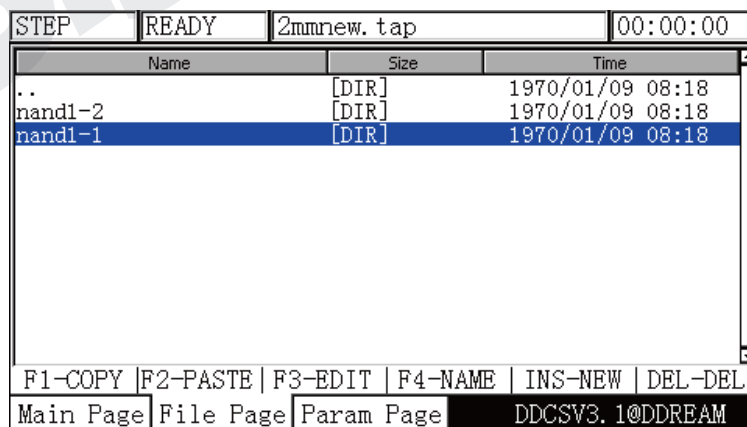


The screenshot shows a file manager interface with a status bar at the top displaying 'STEP', 'READY', '2mmnew.tap', and '00:00:00'. Below this is a table with columns 'Name', 'Size', and 'Time'. The table lists the following items:

Name	Size	Time
udisk-sda	[DIR]	1970/01/09 08:18
udisk-sda1	[DIR]	1970/01/09 08:18
mnt	[DIR]	1970/01/09 08:18
linuxrc	985372	2015/11/04 19:29

At the bottom of the screen, there is a navigation bar with options: 'F1-COPY', 'F2-PASTE', 'F3-EDIT', 'F4-NAME', 'INS-NEW', 'DEL-DEL', 'Main Page', 'File Page', 'Param Page', and 'DDCSV3.1@DDREAM'.

Figure 4-1 Enter into System folder “MNT”



The screenshot shows the file manager interface with the same status bar as Figure 4-1. The table below shows the contents of the 'mnt' folder:

Name	Size	Time
..	[DIR]	1970/01/09 08:18
nand1-2	[DIR]	1970/01/09 08:18
nand1-1	[DIR]	1970/01/09 08:18

The navigation bar at the bottom is identical to Figure 4-1.

Figure 4-2 Setting file is in “nand1-1” from “MNT” folder

STEP		READY	2mmnew.tap	00:00:00
Name	Size	Time		
..	[DIR]	1970/01/09 08:18		
gcode	[DIR]	1970/01/09 08:18		
chs	20427	1970/01/01 00:00		
eng	23144	1970/01/01 00:00		
rus	31142	1970/01/01 00:00		
motion.out	1690862	1970/01/01 00:00		
setting	170000	1970/01/01 00:00		
slib.nc	7876	1970/01/01 00:00		
uservar	2000	1970/01/01 00:00		
gotoz.nc	9	1970/01/01 00:00		
pause.nc	13	1970/01/01 00:00		
m30.nc	0	1970/01/01 00:00		
F1-COPY F2-PASTE F3-EDIT F4-NAME INS-NEW DEL-DEL				
Main Page		File Page	Param Page	DDCSV3.1@DDREAM

Figure 4-3 find the setting file and copy

In the System, the USB memory stick's name is "udisk-sda1"

Open this folder and paste the file by pressing the Shift key

Now the controller setting parameter file is saved on the USB stick.

STEP		READY	2mmnew.tap	00:00:00
Name	Size	Time		
udisk-sda	[DIR]	1970/01/09 08:18		
udisk-sda1	[DIR]	1970/01/09 08:18		
mnt	[DIR]	1970/01/09 08:18		
linuxrc	985372	2015/11/04 19:29		
F1-COPY F2-PASTE F3-EDIT F4-NAME INS-NEW DEL-DEL				
Main Page		File Page	Param Page	DDCSV3.1@DDREAM

Figure 4-4 find the USB-Stick and enter into it

STEP		READY	2mmnew.tap	00:00:00
Name	Size	Time		
..	[DIR]	1970/01/09 08:18		
install	[DIR]	1970/01/09 08:18		
file	[DIR]	1970/01/09 08:18		
2mmnew.tap	1525365	2018/07/15 17:12		
BMP0.bmp	261174	1970/01/01 00:00		
BMP1.bmp	261174	1970/01/01 00:00		
target file.textClipping	207	2019/05/09 15:37		
BMP2.bmp	261174	1970/01/01 00:01		
BMP3.bmp	261174	1970/01/01 00:01		
setting	170000	1970/01/01 00:01		
Bear Shape 3d v2.crv3d	5411840	2016/01/18 16:35		
3D Roughing Bear v2.tap	553829	2016/01/18 16:34		
F1-COPY F2-PASTE F3-EDIT F4-NAME INS-NEW DEL-DEL				
Main Page		File Page	Param Page	DDCSV3.1@DDREAM

Figure 4-5 Copy the setting to USB-Stick

If the user's need to copy the same Parameters Setting in other DDCS controllers, just copy this "setting" file into the system folder, replace the initial setting file.

5 G Code and M Code

Command	Options	Description	Example of use	Description of the example
G0, G00	X Y Z A	Moves the axes to the point X Y Z A, at the speed specified in # 80	G0 X10 Y10 Z1	Quickly moves the axes to the point X10 Y10 Z1
G1, G01	X Y Z A	Moves the axes to the point X Y Z A, at the speed specified in F. If F is not specified, the speed from parameter # 76 is used.	G0 X10 Y10 Z1 F100	Moves the axes to the point X10 Y10 Z1 at a speed of 100
G2, G02 (mode1)	X Y Z I J K	Moving along the arc, clockwise, specified the center, at the speed specified in F. I, J, K are the coordinates of the arc center (x, y, z), relative to the end point (for G91.1) or in absolute coordinates G90.1), K can be omitted. X, Y is the end point of the arc. Z - for plunging into a spiral (end infeed). The starting point of the arc is given by the preliminary movement of the axes into it.	G0 X0.00 Y-50.00 ----- G2 X100.00 Y-50.00 I50.00 J0 F100	Draws half the circle, D = 100, from 0 to 180 degrees, clockwise, at a speed of 100
G3, G03 (mode1)	X Y Z I J K	Moving along the arc, counterclockwise, specified the center, at the speed specified in F. I, J, K are the coordinates of the arc center (x, y, z), relative to the end point (for G91.1) or in absolute coordinates G90.1), K can be omitted. Z - for plunging into a spiral (end infeed). The starting point of the arc is given by the preliminary movement of the axes into it.	G0 X100.00 Y-50.00 ----- G3 X0.00 Y-50.00 I-50.00 J0 F100	Draws half the circle, D = 100, 180 to 0 degrees, counter-clockwise, at a speed of 100
G2, G02 (mode2)	X Y Z R	Moving along an arc, clockwise, specified the radius, at the speed specified in F. R is the radius of the arc. X, Y is the end point of the arc. Z - for plunging into a spiral (end infeed). The starting point of the arc is given by the preliminary movement of the axes into it.	G0 X0.00 Y-50.00 ----- G2 X100.00 Y-50.00 R50 F100	Draws half the circle, D = 100, from 0 to 180 degrees, clockwise, at a speed of 100
G3, G03 (mode2)	X Y Z R	The movement along the arc, counterclockwise, specified the radius, with the speed specified in F. R is the radius of the arc. X, Y is the end point of the arc. Z - for plunging into a spiral (end infeed). The starting point of the arc is given by the preliminary movement of the axes into it.	G0 X100.00 Y-50.00 ----- G3 X0.00 Y-50.00 R50 F100	Draws half the circle, D = 100, 180 to 0 degrees, counter-clockwise, at a speed of 100
G4, G04	P	Stops processing for the number of milliseconds specified after P. In this case, the machine does not stop the spindle and does not pick up the tool	G4 P10000	Stops processing for 10 seconds
G12	I	Draws a circle clockwise, around the current location XY, with the speed F. Without correction for the diameter and without moving Z. I - is the radius of the circle.	G12 I10	Draws a circle with a diameter of 20 mm, clockwise
G13	I	Draws a circle counter-clockwise, around the current location XY, with a speed F. Without correction for the diameter and without moving Z. I - is the radius of the circle	G13 I10	Draws a circle with a diameter of 20 mm, counter-clockwise
G17		Selecting the working plane X-Y	G17	Select the working plane X-Y
G18		Selection of working plane Z-X	G18	Select of working plane Z-X
G19		Selection of working plane Y-Z	G19	Select of working plane Y-Z
G20		Inch system selection	G20	Inch system selection
G21		Choice of metric system	G21	Metric system selection

Command	Options	Description	Example of use	Description of the example
G28	XYZA	Go back to the reference point. Works only with G91. The specified axes, first move to the specified point, then to the machine 0. If 0 is specified, then immediately into the machine zero. The not specified axes do not move.	G91 G28 X10 Y0 Z0	The X axis will first move 10mm to the right, then the XYZ axes will go to the machine axis 0. Axis A does not move.
G40	NO	Cancel tool radius compensation. The function does not work yet.	G40	Cancel tool radius compensation.
G41	D	Compensate the tool radius to the left of the path. D - is the tool number from the table. The function does not work yet.	G40	Compensates the tool radius 1, to the left of the path.
G42	D	Compensate tool length positively. H - the number of the instrument according to the table. The function does not work yet.	G42 D1	Compensates the length of tool 1 positively.
G43	H	Compensate tool length positively. H - the number of the instrument according to the table. The function does not work yet.	G43 H1	Compensates the length of tool 1 positively.
G44	H	Compensate for the length of the instrument is negative. H - the number of the instrument according to the table. The function does not work yet.	G44 H1	Compensates the length of tool 1 negatively.
G49	H	Cancel tool length compensation. The function does not work yet.	G49	Cancel tool length compensation
G53	H	malfunctioning, working analog G153	G44 H1	Compensates the length of tool 1 negatively.
G54 - G59	XYZA	Selecting the coordinate system	G54	Selecting a coordinate system
G73	XYZRQIK	The cycle of step drilling with the full output of the drill, with the speed F. X, Y - the coordinates of the center; Z - is the distance from R to the bottom of the hole; R - drilling depth (usually, 0); Q - is the step size; I - distance of failure to return to G0; K - is the number of repetitions. The drill is retracted and fed at a speed of G0, which can be limited by parameters # 78 and # 79.	G83 X10 Y5 Z-7 R0 Q1,4 I0 K1 F300	Drills the hole at point X10 Y5, from 0 to 7mm, at a speed of 300 mm / min. The step size is 1.4mm, thus 5 steps are done. After each step, the drill is retracted by 1mm.
G81	XYZRK	Drilling in 1 pass, with speed F. X, Y - coordinates of the center; Z is the distance from R to the bottom of the hole; R - drilling depth; K is the number of repetitions.	G81 X10 Y5 Z-7 R0 K1 F300	Drills the hole at point X10 Y5, from 0 to 7mm, at a speed of 300 mm / min.
G82	XYZRKP	Drilling in 1 pass with a delay at the end (for better processing of the bottom), with speed F. X, Y - coordinates of the center; Z - is the distance from R to the bottom of the hole; R - drilling depth; K - is the number of repetitions, P - is the delay in milliseconds.	G82 X10 Y5 Z-7 R0 K1 P2000 F300	Drills the hole at point X10 Y5, from 0 to 7mm, at a speed of 300 mm / min. At the bottom of the drilling, the pause is 2 seconds.
G83	XYZRQIK	The cycle of step drilling with the full output of the drill, with the speed F. X, Y - the coordinates of the center; Z - is the distance from R to the bottom of the hole; R - drilling depth (usually, 0); Q - is the step size; I - distance of failure to return to G0; K - is the number of repetitions. The drill is retracted and fed at a speed of G0, which can be limited by parameters # 78 and # 79.	G83 X10 Y5 Z-7 R0 Q1,4 I0 K1 F300	Drills the hole at point X10 Y5, from 0 to 7mm, at a speed of 300 mm / min. The step size is 1.4mm, thus 5 steps are done. Failure = 0, in this way the drill is returned on fast feed to the end point of the previous step.

Command	Options	Description	Example of use	Description of the example
G90	No	For G0/G1:Specifying absolute coordinates; For G2/G3:The main coordinates are absolute and the centers of the arcs are relative.	G90 G1 X10 Y0 G90 G2 X20 I5 G2 X10 I-5	
G91	No	For G0/G1:Specifying relative coordinates; For G2/G3:The main coordinates are relative and the centers of the arcs are relative.	G90 G1 X10 Y0 G91 G2 X10 I5 G2 X-10 I-5	
G90.1	No	For G0/G1:Specifying absolute coordinates; For G2/G3:The main coordinates are absolute and the centers of the arcs are absolute.	G90 G1 X10 Y0 G90.1 G2 X20 I15 G2 X10 I15	
G91.1	No	For G0/G1:Specifying relative coordinates; For G2/G3:The main coordinates are relative and the centers of the arcs are absolute.	G90 G1 X10 Y0 G90.1 G2 X20 I15 G2 X10 I15	
G92	X Y Z A	Setting new current coordinates	G90G92X0Y0Z0A0	Zero all axes
G93	F	Inverse time feed mode,This G code specifies that all F (feedrate) values are interpreted as strokes per minute. In other words the time (in seconds) to complete the programmed motion using G93 is, 60 (seconds) divided by the F value.	G93 G01 X5 Y5 A180 F6	This path will be completed in 10s. (Considering the speed limit of each axis and the acceleration/deceleration time, the actual time may be longer than 10s)
G94	No	The units per minute feed mode,In units per minute feed rate mode, an F word (no, not that F word; we mean feedrate) is interpreted to mean the controlled point should move at a certain number of millimeters per minute, or degrees per minute, depending upon what length units are being used and which axis or axes are moving.	G94 G01 X5 Y5 A180 F3000	This path will move at a synthetic speed of no more than 3000 units/min.
G98	No	After drilling cycles, the tool returns to the Z position, before the start of the cycle. Raises the Z axis to a safe height..	G98 ----- G1 Z1 F1000 ----- G81 X0 Y0 Z-7 R0 K1 F300	After drilling, the tool will be in position 1 to Z
G99	No	After the drilling cycles, the tool returns to the point R (along the Z axis). Raises the Z axis to a safe height.	G99 ----- G1 Z1 F1000 ----- G81 X0 Y0 Z-7 R0 K1 F300	After drilling, the tool will be in position 0 to Z

A) G93 : When G93 is used, feedrate (F) is mandatory for all interpolated motion blocks. Therefore each non-rapid motion block must have its own feedrate (F) specification. Requires version 2019-05-27-111 or later

Command	Options	Description	Example of use	Description of the example
G102	X Y A B C L	Construct an ellipse sector clockwise, around the current position. X - is the width; Y - height; A - is the angle of rotation of the ellipse; B - the initial angle of the sector; C - is the end angle of the sector; L - resolution of circular interpolation (angle, less-better). That is, with L = 1, the ellipse will look like a 360 angle. And with L = 90 - as a quadrilateral.	G102 X20 Y10 A0 B0 C300 L1 F500	Constructs an ellipse sector, clockwise, 20mm wide, 10mm high, 0 to 300g, discreteness, 1 degree, speed 500.
G103	X Y A B C L	Construct an ellipse sector counter-clockwise, around the current position. X - is the width; Y - height; A - is the angle of rotation of the ellipse; B - the initial angle of the sector; C - is the end angle of the sector; L - resolution of circular interpolation (angle, less-better). That is, with L = 1, the ellipse will look like a 360 angle. And with L = 90 - as a quadrilateral.	G103 X20 Y10 A0 B0 C300 L1 F500	It builds an ellipse sector, counterclockwise, 20mm wide, 10mm high, 0 to 300g, discreteness, 1 degree, 500 speed.
G110	X Y Z R	Rectangular pocket, but without circumvention, the type of filling is zigzag. X Y - height and width, Z - pocket depth, R - tool radius. Constructed from the bottom left corner (current position).	G110 X10 Y15 Z-0,5 R2 F500	It builds a rectangular pocket, 10mm wide, 15mm high, 0.5mm deep, with a 4mm cutter, with a speed of 500.
G111	I Z R	The round pocket is clockwise, the type of filling is a spiral. I - radius of a circle, Z - depth, R - tool radius. Constructed from the center (current position).	G111 I10 Z-0,5 R1 F500	It builds a round pocket, with a diameter of 20 mm, a depth of 0.5 mm, with a 2 mm cutter, with a speed of 500.
G112	I Z R	Round pocket counter-clockwise, type of filling - spiral. I - radius of a circle, Z - depth, R - tool radius. Constructed from the center (current position).	G112 I10 Z-0,5 R1 F500	It builds a round pocket, with a diameter of 20 mm, a depth of 0.5 mm, with a 2 mm cutter, with a speed of 500.
G153	X Y Z A	Analog G53, moving to machine coordinates, with speed F.	G153 X0 Y0 Z0 A0 F3000	Moves all axes, to machine 0, at a speed of 3000

Command	Options	Description	Example of use	Description of the example
M0, M00	No	Stopping the program, before pressing the "START" button, is completely the same as pressing the "PAUSE" button.	M0	Stops the program, before pressing the "START" button. Raises the Z axis and sets the spindle, if it is set in the settings.
M3, M03	S	Start spindle rotation with speed S	M3 S2000	Starts the spindle at a speed of 2000 rpm
M5, M05		Stop the spindle	M5	Stops the spindle
M6, M06	T	Plays the contents of the T.nc. file Specifies the tool number for offsets. T specifies the number of the tool (it can be omitted).	M6 T5	Replaces the tool with №5
M8, M08	No	Switch on spindle cooling	M8	Switch on spindle cooling
M9, M09	No	Switch off spindle cooling	M9	Switch off spindle cooling
M10	No	Turn on the coolant pump	M10	Turn on the coolant pump
M11	No	Turn off the coolant pump	M11	Turn off the coolant pump
M30	No	End of the program, cancels all commands and loops. Do not use immediately after M6.	M110	It stops the program, before pressing the "START" button. Peep 3 times with built-in peepal
M101	No	Start monitoring the probe signal during the machining process. If the probe signal appears in the subsequent movement, the motion will stop. At this point, you can get the coordinate information through the macro variable.	M101 (open probed function) G91 G01 Z-50.0 F500.0 (Z axis moves down 500mm, in this process, if the probe signal appears, the motion will stop) M102(turn off the probed function) G04P0(synchronous)	
M102	No	turns off the monitoring of the probe signal.	G90 G92 Z0.0(Set the current workpiece coordinate system Z-axis coordinate to 0.0) In order to use the above features, your version requires Ver: 2018-10-12-102 or later.	
M105	No	X-axis homing operation	M105	In order to use the above features, your version requires Ver: 2019-04-28-108 or later.
M106	No	Y-axis homing operation	M106	
M107	No	Z-axis homing operation	M107	
M108	No	A-axis homing operation	M108	
M110		Stop the program, before pressing the "START" button, without moving the axes. Plays a sound signal (useful for manual tool change).	M110	It stops the program, before pressing the "START" button. Peep 3 times with built-in peepal
()	No Application	The comment character. In any line with a comment, only the contents of the brackets are displayed on the screen (increases the space for the name of the instrument).	G153 Z0 ----- M110(T5 cutter 5mm single-pass)	Raises the Z axis to zero, to manually change the tool, stops the program before pressing the "START" button, feeds 3 times with the built-in pshchalko, as a result, only "T5 cutter 5mm single-pass" will be written on the screen. Without brackets and M110. by 1mm.

Command	Options	Description	Example of use	Description of the example
F	No Application	Sets the speed of the working feed, for many commands. You can write, as at the end of the line with the command, and a separate line. If F is not specified anywhere, the speed from parameter # 76 is used.	F100 ----- G1X10.5	Moves the X axis to, at point 10.5, at a speed of 100.
P	No Application	Specifies the pause time, in milliseconds, for the G4 and G82 commands. You can write, as at the end of the line with the command, and a separate line.	P2000 ----- G4	Pauses the program for 2 seconds
S	No Application	Specifies the spindle speed for the M3 command. You can write, as at the end of the line with the command, and a separate line.	S21000 ----- M3	Starts the spindle at a speed of 21000 rpm
▪	No Application	The symbol for dividing the whole and fractional parts of numbers. Comma - does not work.	G0 X10.5	Moves the X axis on fast feed, to the point 10.5. Option G0 X10.5 - will not work.
SIN	[n]	The sine of the parameter n, in degrees.	#1=SIN[30.0]	
COS	[n]	The cosine of the parameter n, in degrees.	#1=COS[60.0]	
TAN	[n]	The tangent of the parameter n, in degrees.	#1=TAN[45.0]	
SQRT	[n]	The square root of the parameter n.	#1=SQRT[2.0]	
ATAN	[n1,n2]	returns the angle between the ray to the point (n1,n2) and the positive x-axis, confined to (-180, 180).	#1=ATAN[30,10]	
ABS	[n]	returns the absolute value of that parameter n.	#1=ABS[-30.1]	
ClearCoords	[n]	clear the contents of the coordinate file on the USB stick. n is the file serial number.	ClearCoords[2]	The contents of the "ProbeMap2.txt" file of the USB stick will be erased.
RecordCoords	[n,x,y,z,a]	which can append 4 floating point numbers(x,y,z,a) to the specified file on the USB stick. The first parameter(n) is the file serial number, and the next 4 parameters are the recorded data.	RecordCo-ords[3,10.2,5.3,0,0]	"10.2000, 5.3000, 0.0000, 0.0000" will be added to the "ProbeMap3.txt" file of the USB stick.
GetCenterPos	[x1,y1,x2,y2,x3,y3,n1,n2]	Find the center of the circle through the 3 points on the circle. x1, y1 is the x-y coordinate of the first point; x2, y2 are the x-y coordinates of the second point; x3, y3 are the x-y coordinates of the third point; n1 is a variable index storing the X coordinate of the center, for example, n1=4, then #4=x coordinate of the center; n2 is a variable index storing the Y coordinate of the center, for example, n2=5, then #5=y coordinate of the center;	GetCenter-Pos[#10,#11,#12,#13,#14,#15,16,17]	Calculate the center coordinates and store them in #16, #17 variables

- A) M105 : Requires version 2019-04-28-108 or later;
- B) M106 : Requires version 2019-04-28-108 or later;
- C) M106 : Requires version 2019-04-28-108 or later;
- D) M106 : Requires version 2019-04-28-108 or later;
- E) ClearCoords : Requires version 2019-05-16-109 or later;
- F) RecordCoords : Requires version 2019-05-16-109 or later;
- G) GetCenterPos : Requires version 2019-05-16-109 or later.

6 Questions and Answer

Q1: When I power on my controller there is beep and Reset signal is flickering,I pressed Reset button many times but still cannot work normally?

A: 1) Please check if the Reset signal of the MPG is active,you can turn off the MPG Estop Function with #428 or change the level logic with #429;

2) Please check the “External Key” which defined as RESET and if this was was triggered,you can modify the definition;

Q2: I believe all my wiring connections of Input and Output signal are correct, but the signal still is disabled?

A: DDCS V3.1 controller need two power supplies to work properly.One is for controller system one is for IO port.Only when with IO power is supplied,the Input and Output signals and the MPG function can have power to work.Refer to § 2.1 for more information.

Q3: I believe my wiring connections for the MPG are correct but MPG still doesn’ work properly?

A: The MPG need the IO power to work,please check the IO port power supply.

Q4: When I stopped turning the handwheel on MPG,but the machine is still moving?

A: : If #448=0, [Open] the MPG control Mode means the MPG will work in open loop mode. If you turn the handwheel faster than the drives can move an axis, the system will store the pulses and sends them to the drivers even after you have stopped turning the handwheel. This can lead to crashes. If you want the system to stop when you stop then set parameter #448=1.

For more information see the comment on #448.

Q5: When I power on the controller,my screen always stay at the Open page?

A: Please go to the website and download the latest install file,upgrade your controller.If still same problem,contact the factory and ask for maintenance.

Q6: Why does my controller always s stay stuck at one page, I cannot change it even I do a lot of operations?

A:

1) Check if the soft limit signal or hard limit signal is triggered;

2) The main program number of DDCS is 0. Check that in the G-code file which you are running is there a program numbered O100. If so change it to “ o000” .

Q7: When I have set the controller language to Eng in the Parameters Page, my controller still displays in Chinese?

A: After setting a new language, please restart your controller, then your controller will display the language which you set.

Q8: In the processing period, nothing happened even after I pressed any buttons.

A: The problem maybe from electromagnetic interference, the solutions are:

1: Don't use the USB cable, just insert the USB memory stick into the controller USB port.

2: The metal part of the USB cable must not touch with the controller box, and also you can use a Ferrite core on the USB cable to try to ignore the noise..

3: The wiring from the inverter to controller, please use the shielded cable, especially the wiring from the servo system to controller, the user must use the shielded cable, to avoid interference.

Q9: Can the Homing signal and Limit signal share one switch?

A: Yes you can.

Q10: Why is my toolpath display not compatible with the screen, or is my toolpath display frozen?

A: When you use a new G-code file, and it's the first time the controller runs the file, the toolpath display maybe too small or too big for the screen, if this happens please don't display the toolpath. Just let the controller run through the file completely. After this the controller will know the size of the file, so next time the system can adjust the display accordingly and show a correctly sized toolpath.

Q11: How can I Plug a USB-Stick and a Keyboard at the same time cause there is only 1 USB port on the controller?

A: The users can use a USB Hub with more than 2 USB ports. The Picture for the references:



Q12: I have checked all the wiring and my settings, I believe all are correct, but the Controller still will not run a file correctly. If I need to contact technology support, which files should I send to the factory for troubleshooting?

A:

- 1) setting file in controller system. Ref [4.2]
- 2) The G-code file you are running
- 3) Description of the problem
- 4) The software version you are running and the controller hardware version [1.1, 2.1, 3.1]
- 5) If appropriate/possible a video of the problem

Please send the files to info@ddcnc.com, we will use your files to check out problem.

Digital Dream
DREAM 智联拓